

## EN: LUMITRACK – USER MANUAL

### BATTERY CHARGING

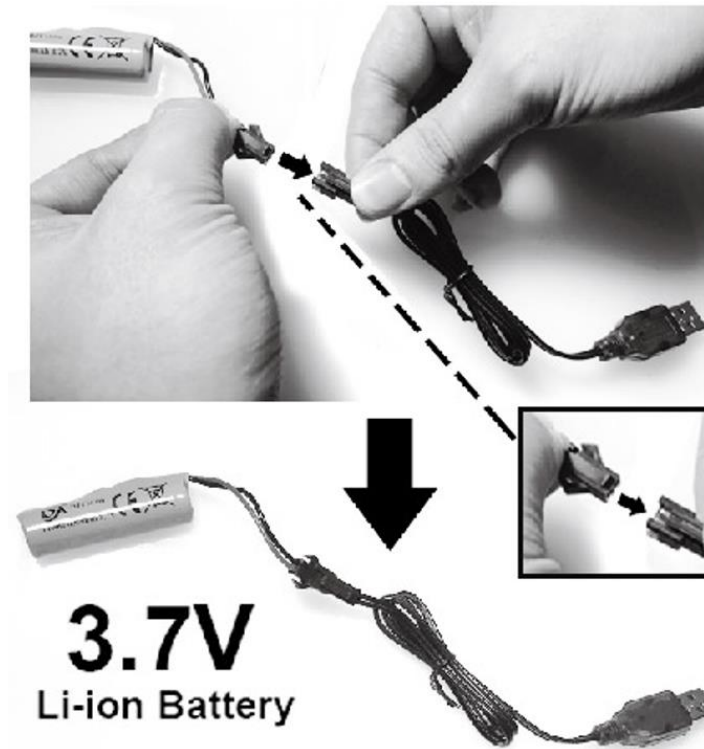

The 3.7V Li-ion battery and charger are included in the product packaging.

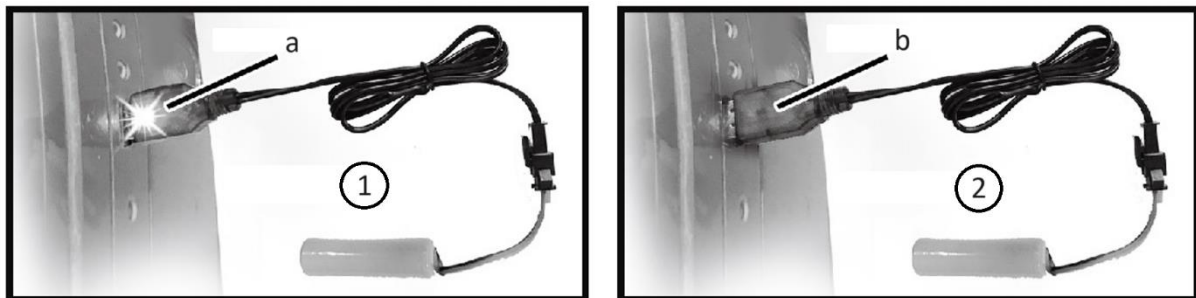

1. Battery charging
  - a) Bright lights
2. Battery fully charged
  - b) No lights

When fully charged, the product shines for 70-90 minutes.

CAR ASSEMBLY INSTRUCTIONS

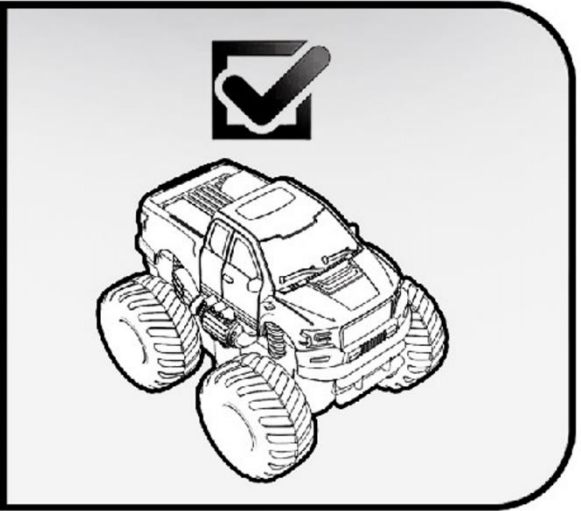
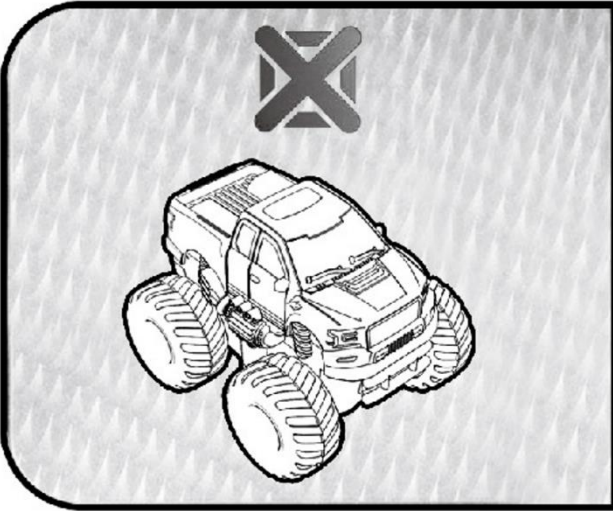
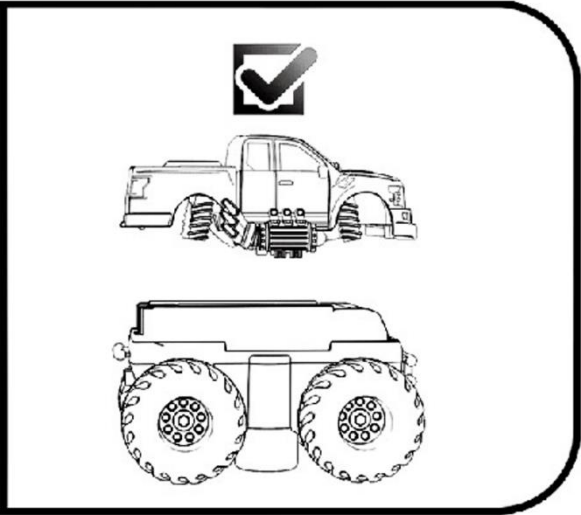
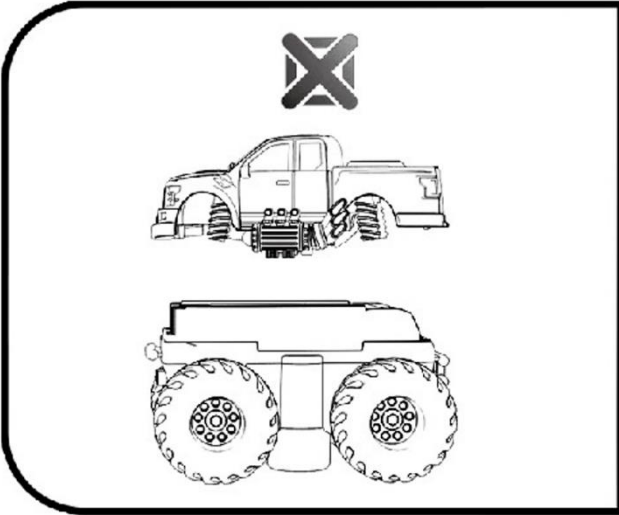
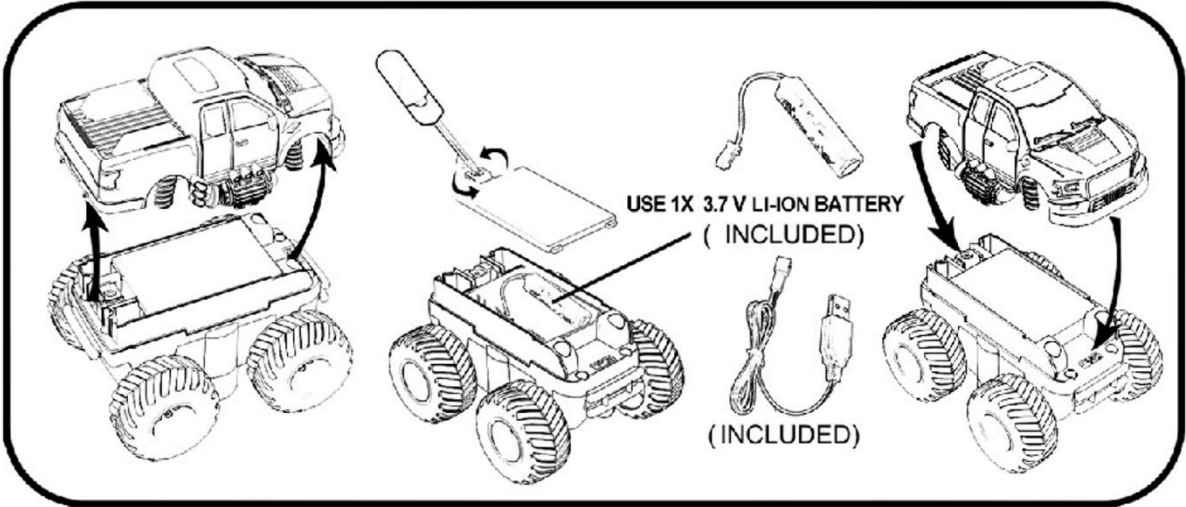

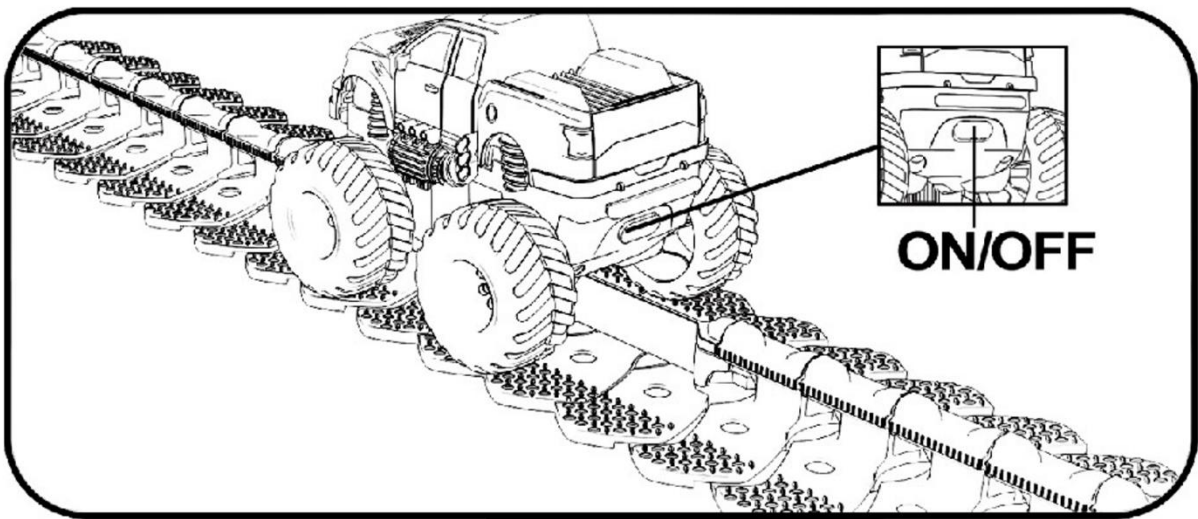
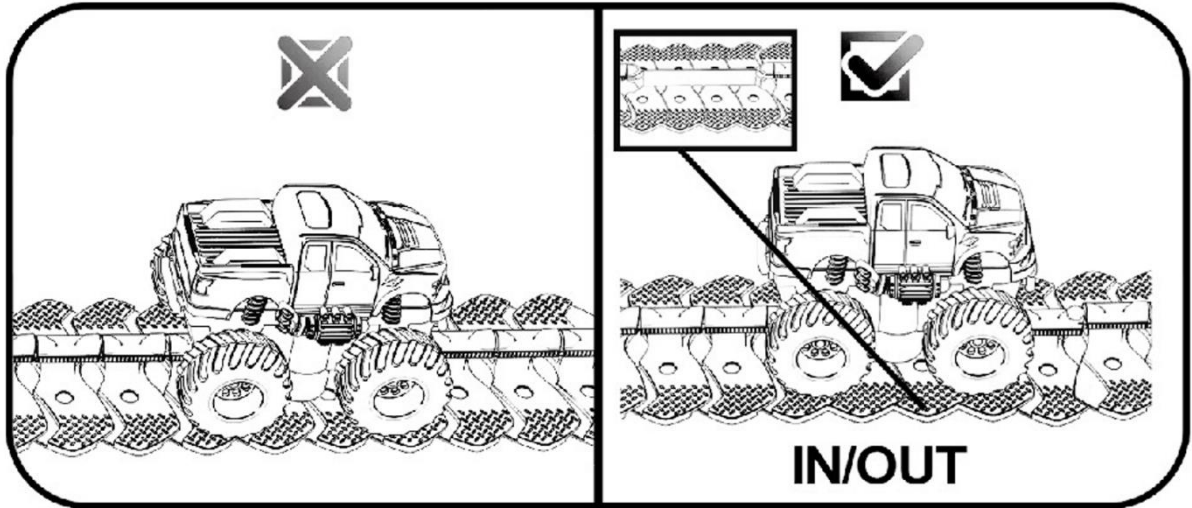

LABELS PLACEMENT: CAR 1







LABELS PLACEMENT: CAR 2

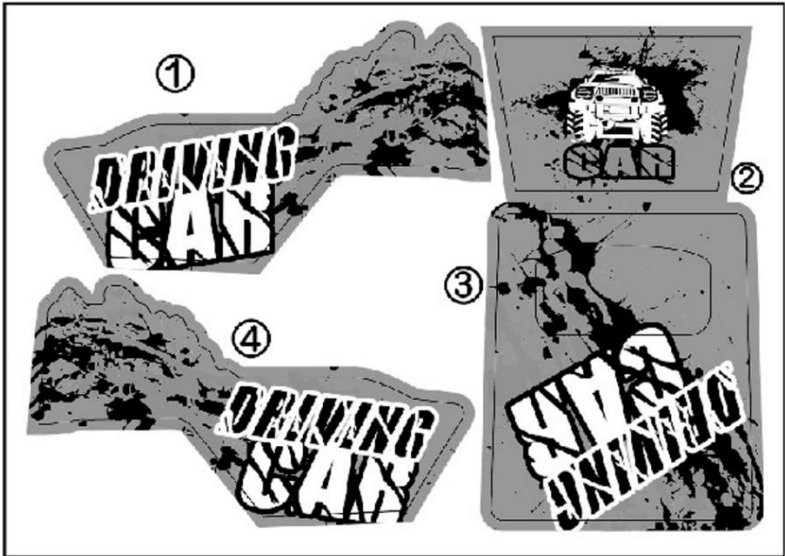



**TRACKS ASSEMBLY**

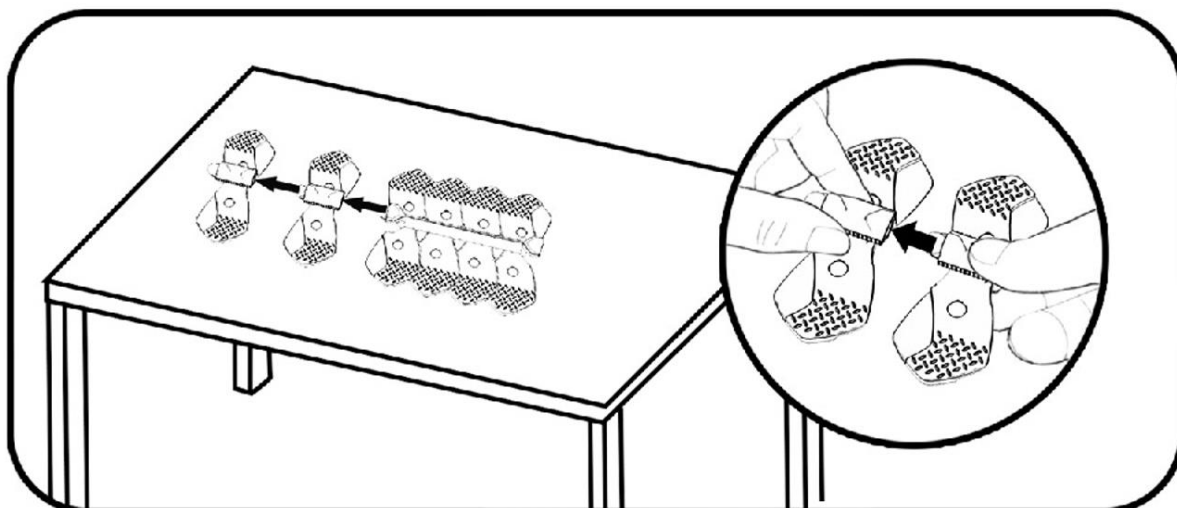



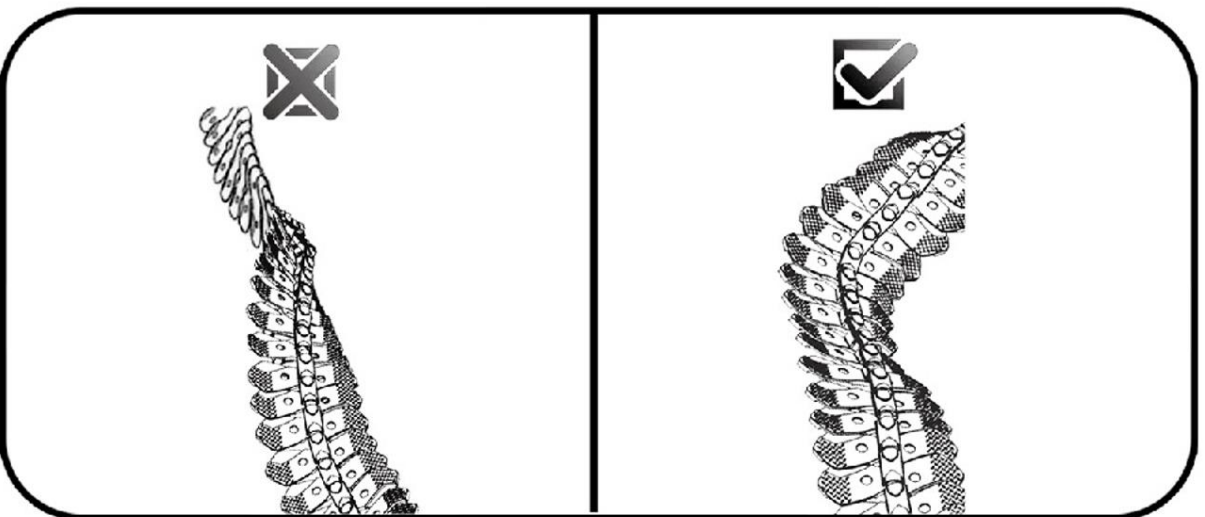
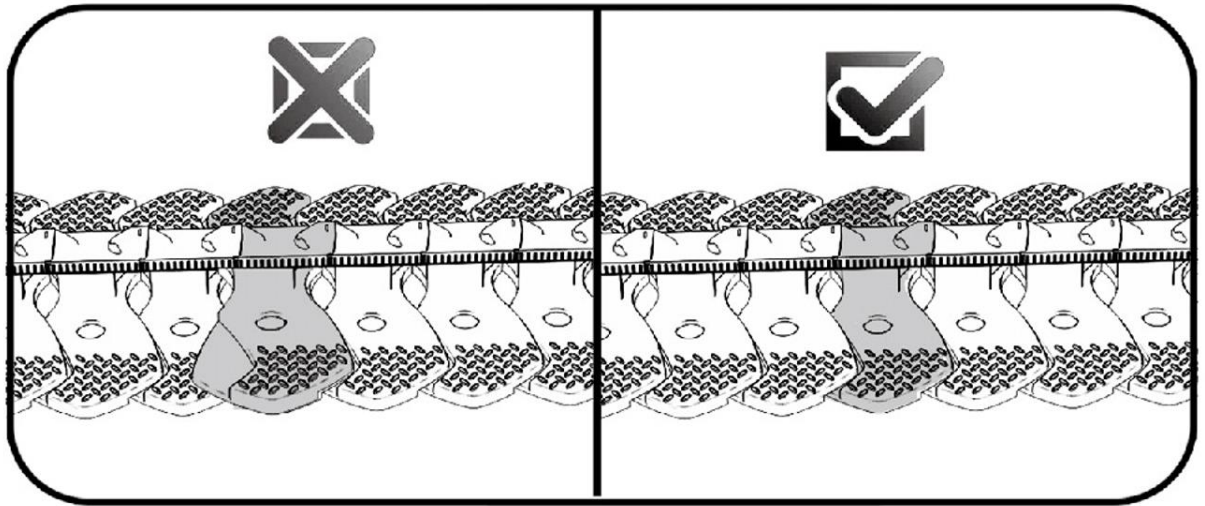
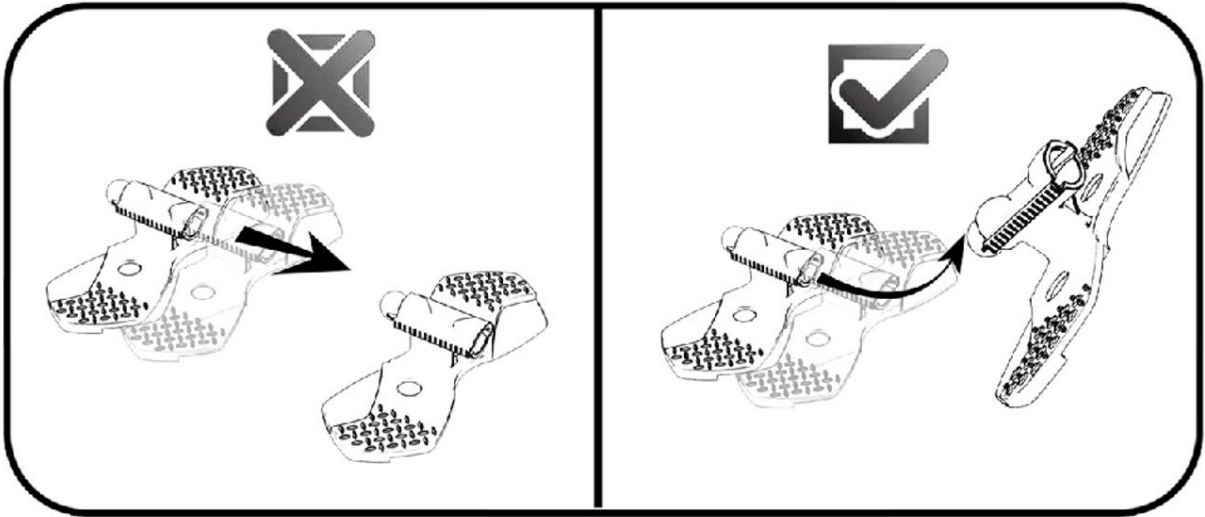

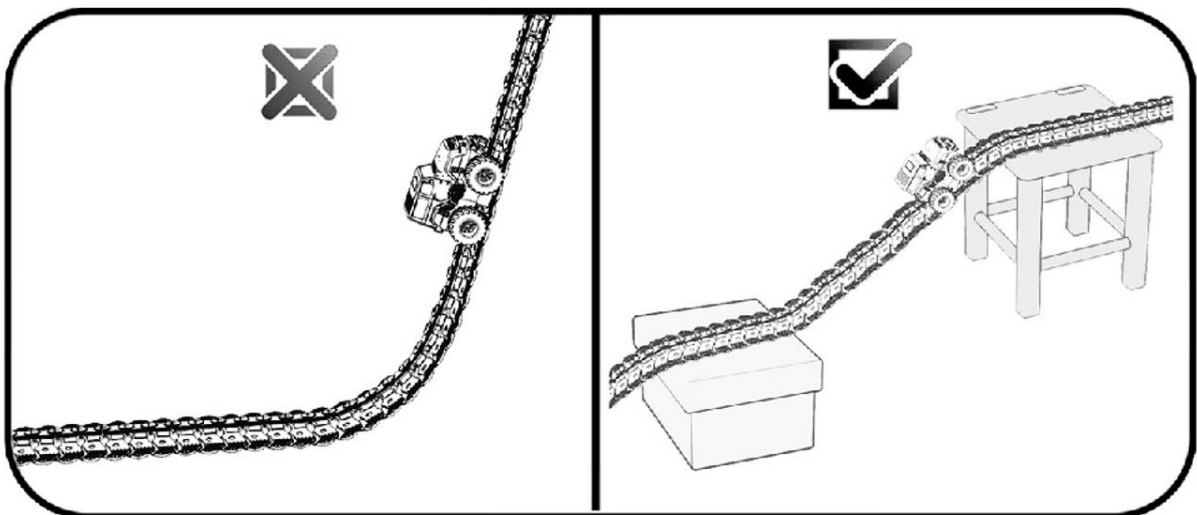
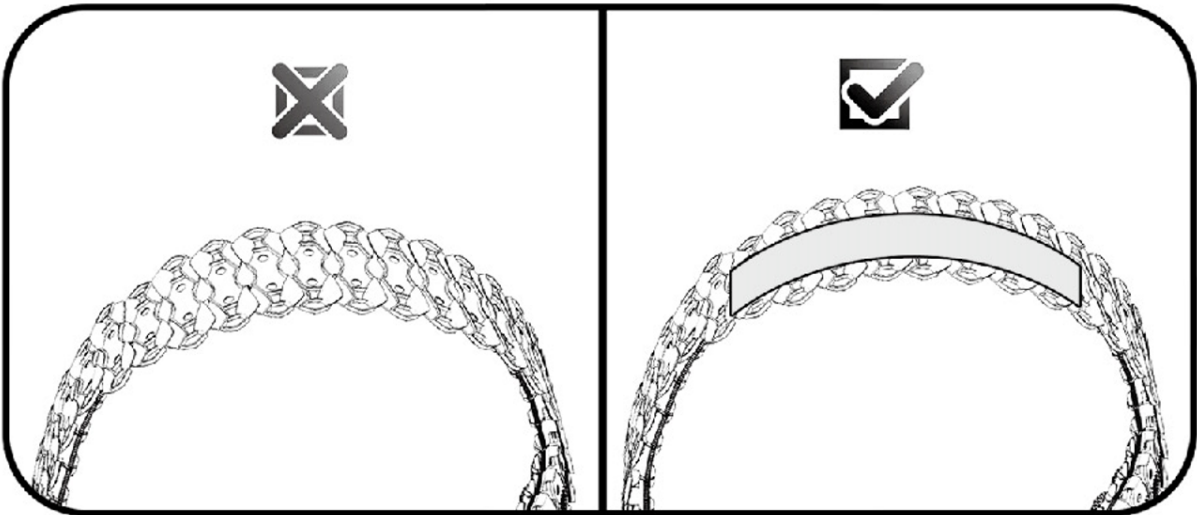
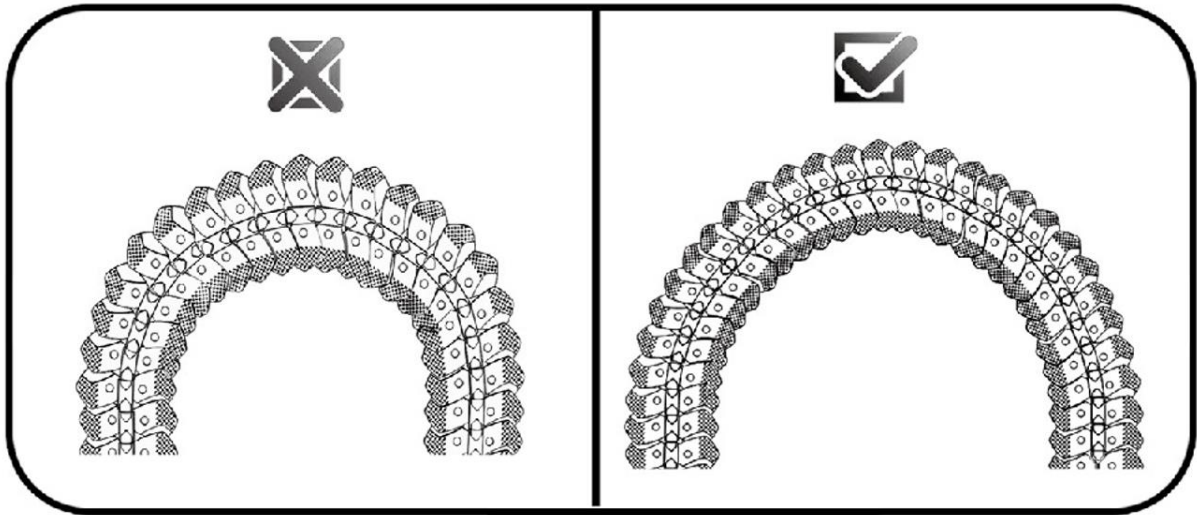



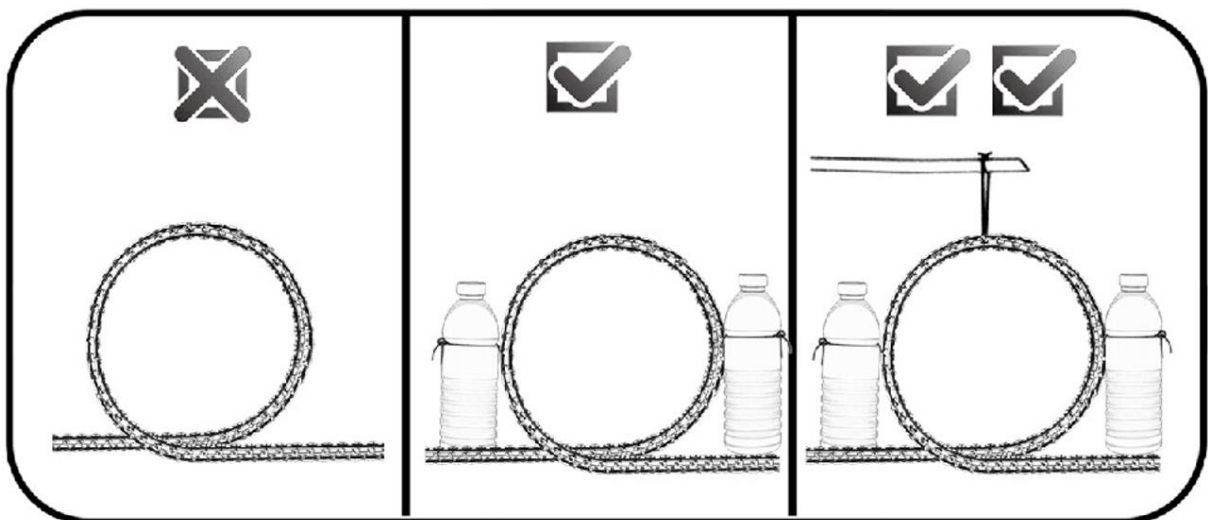
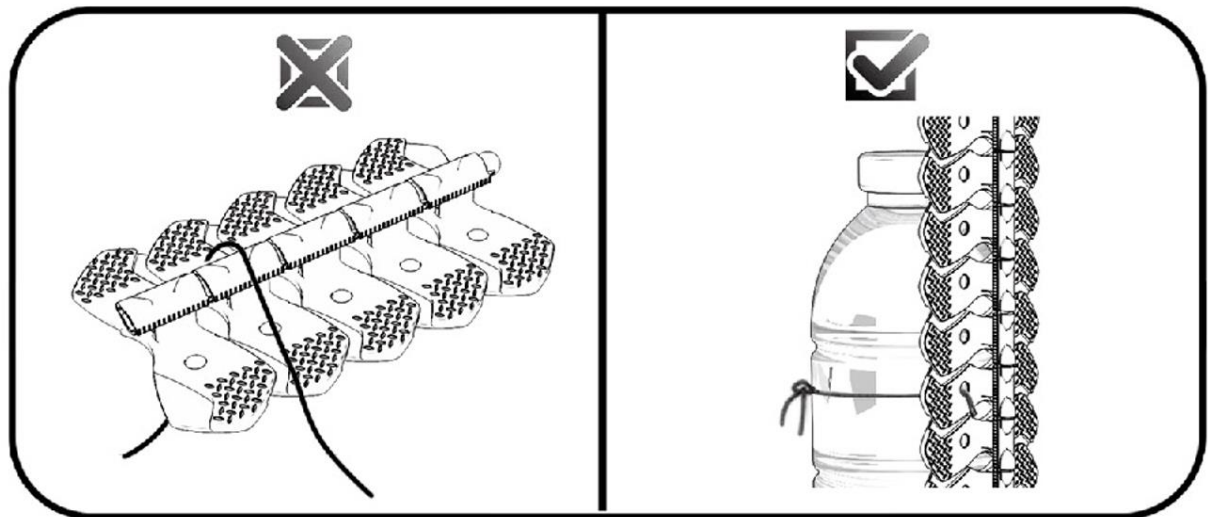
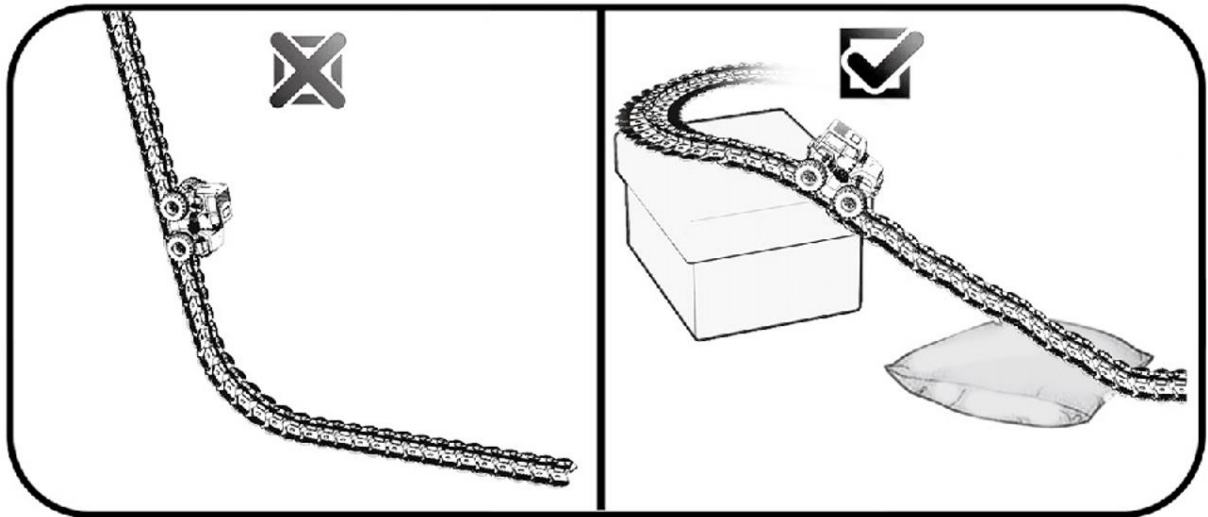

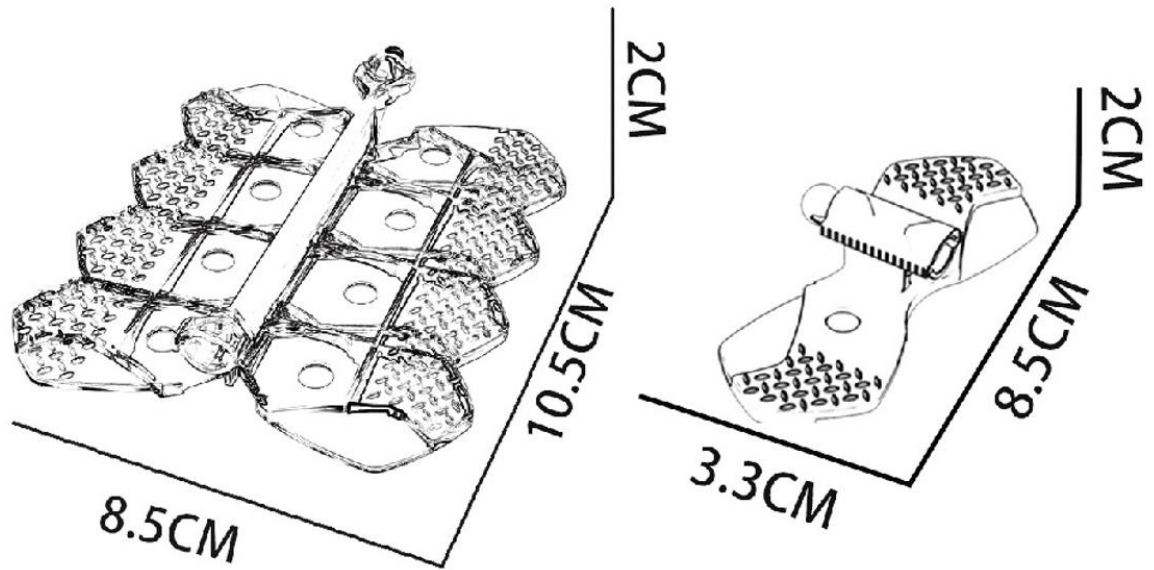

**INSTRUCTIONS FOR RECYCLING AND DISPOSAL:**



This label means that the product cannot be disposed of as other household waste throughout the EU. To prevent potential damage to the environment or human health from uncontrolled waste disposal. Recycle responsibly to promote the sustainable use of material resources. If you want to return a used device, use the drop-off and collection system, or contact the retailer from whom you bought the product. The retailer can accept the product for environmentally safe recycling.



A declaration by the manufacturer that the product complies with the requirements of the applicable EU Directives.

## SI: LUMITRACK - NAVODILA ZA UPORABO

### POLNENJE BATERIJE

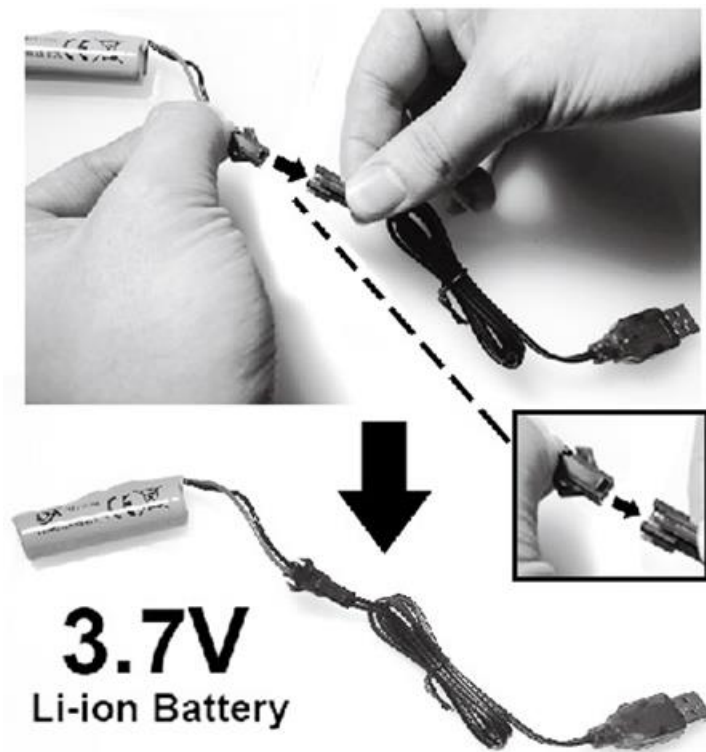

3,7-voltna litij-ionska baterija in polnilec sta priložena v embalaži izdelka.

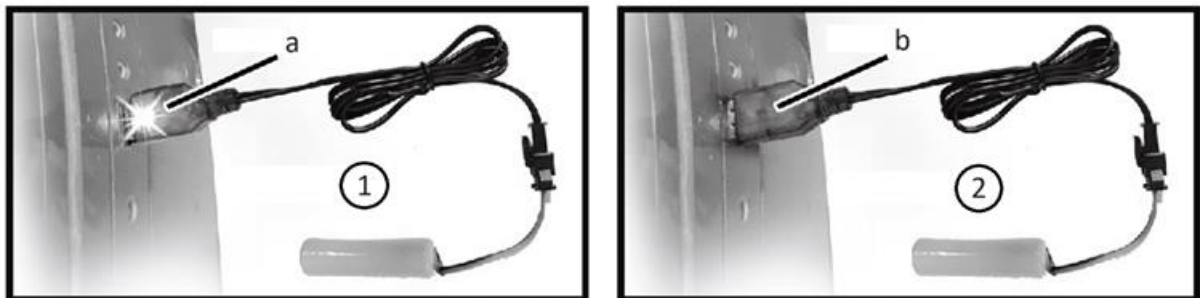

1. Polnjenje baterije
  - a) Svetle luči
2. Baterija je popolnoma napolnjena
  - b) Brez luči

Ko je baterija popolnoma napolnjena, izdelek sveti 70-90 minut.



NAVODILA ZA SESTAVLJANJE AVTOMOBILA

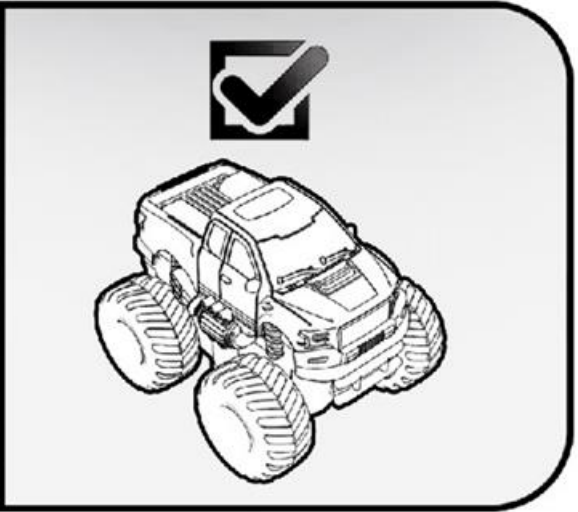
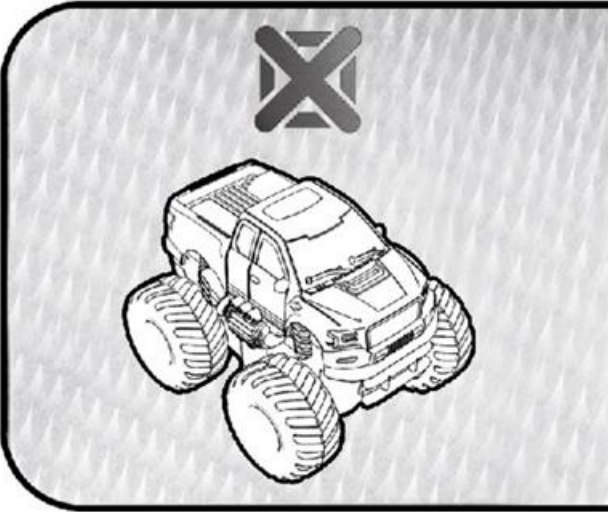
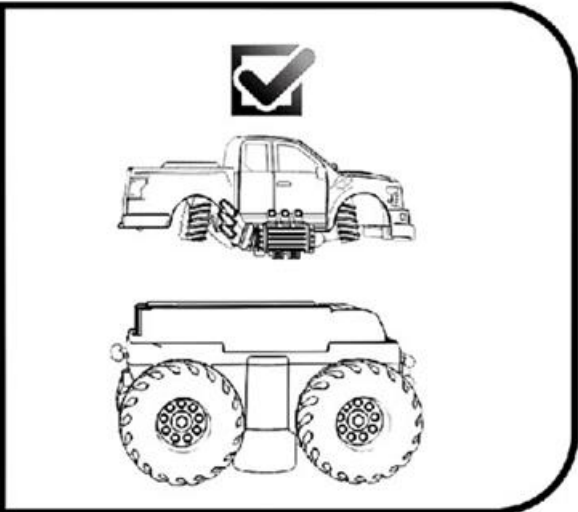
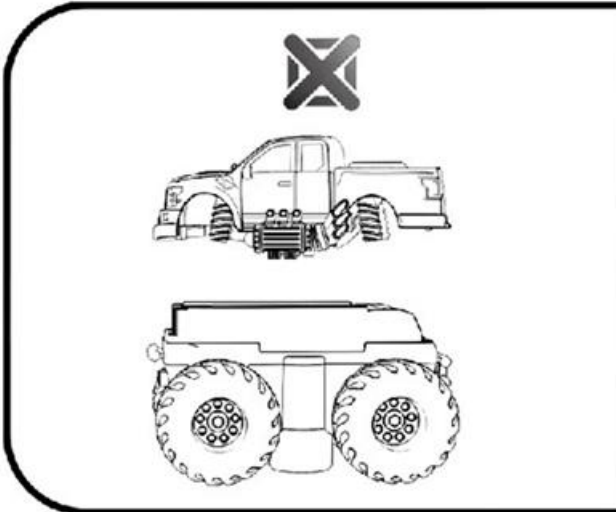
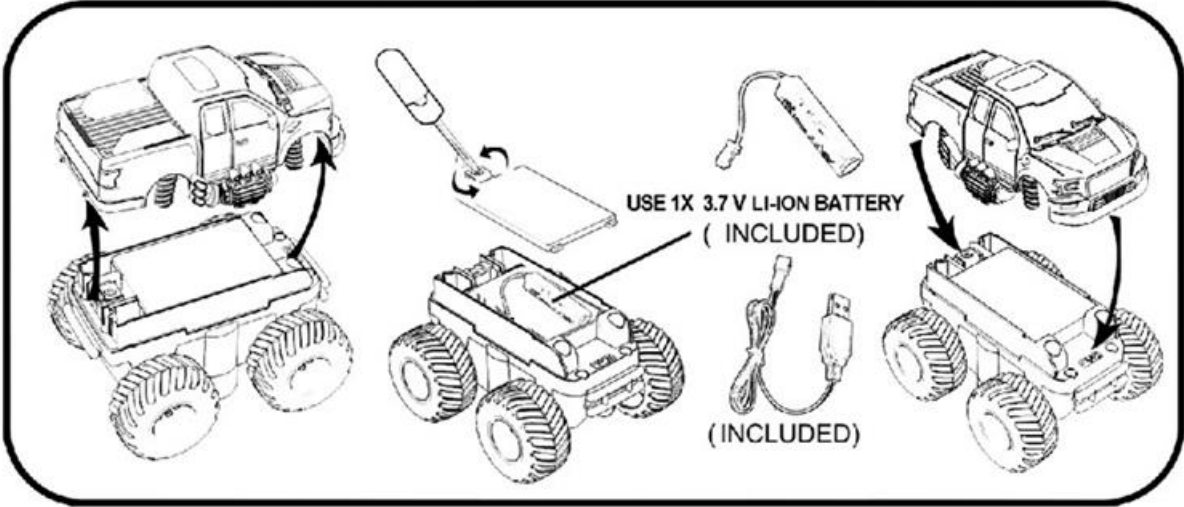

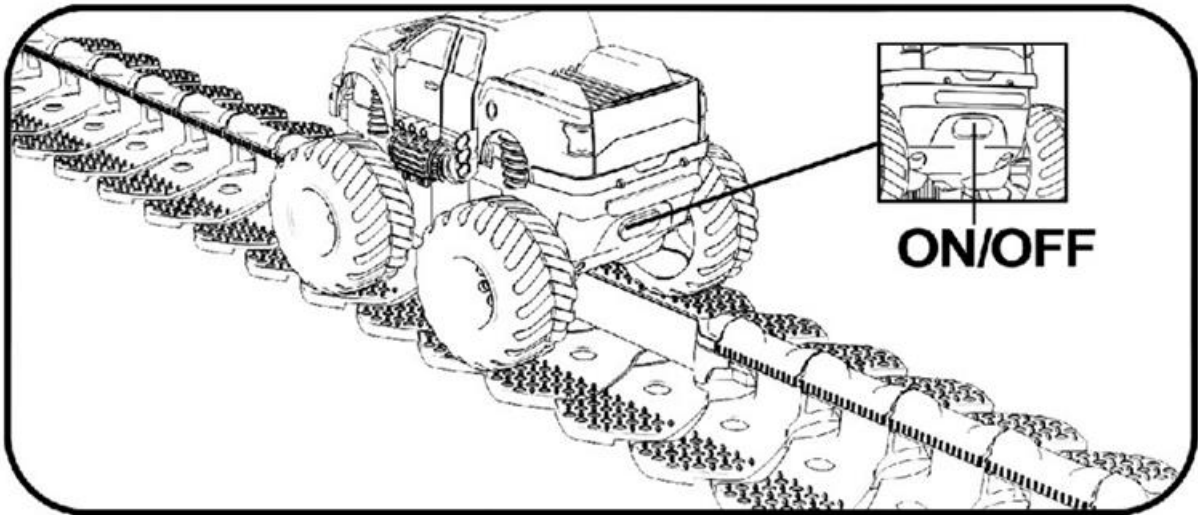
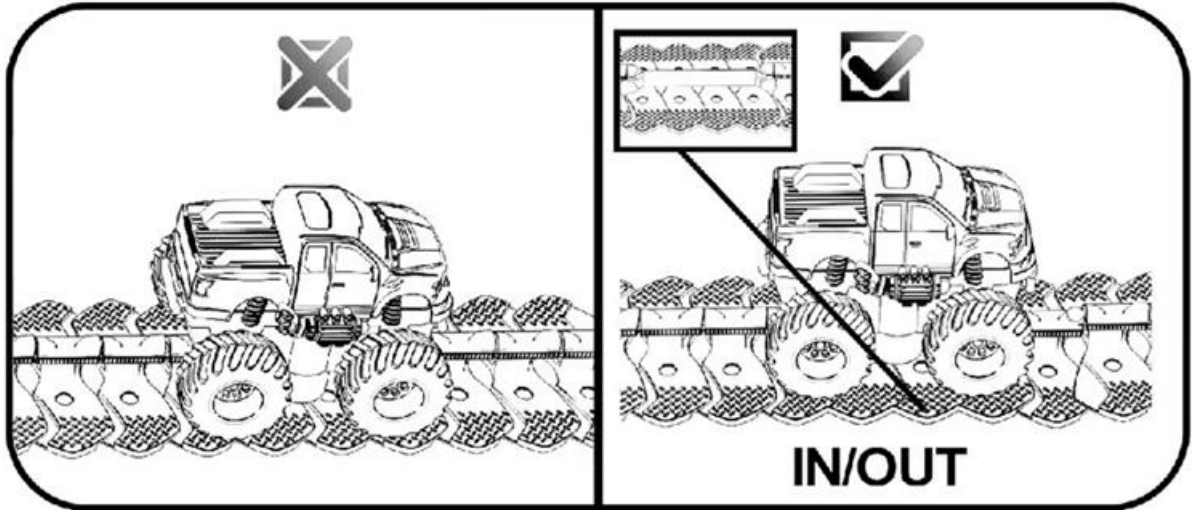

NAMESTITEV NALEPK: AVTO 1







NAMESTITEV NALEPK: AVTO 2

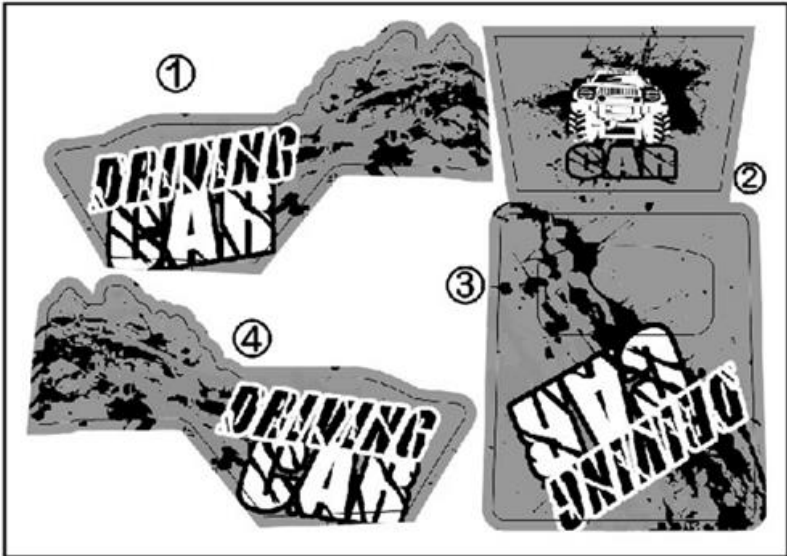



#### SESTAVLJANJE TIRNIC

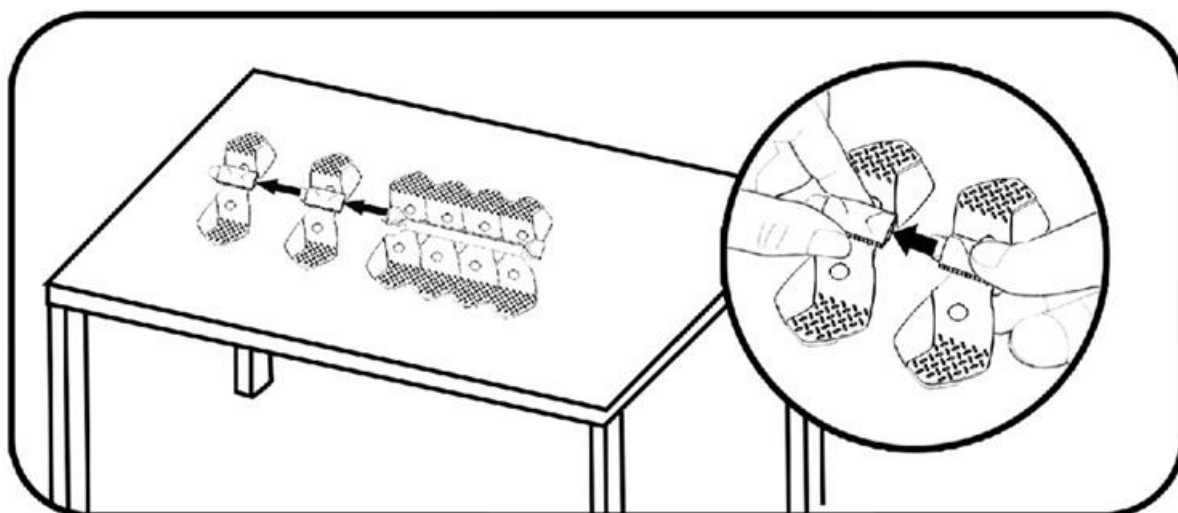

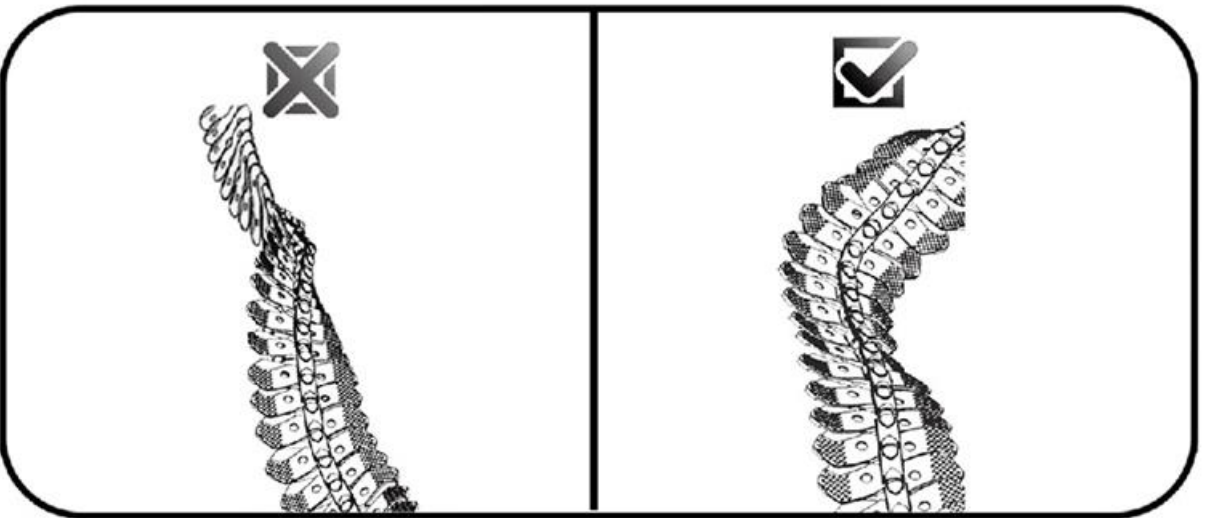
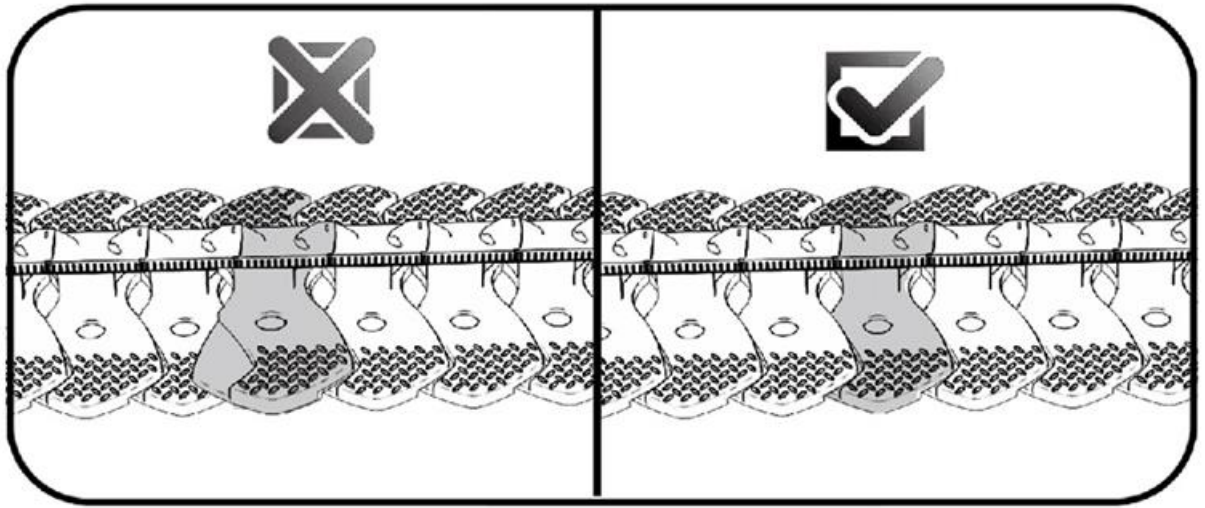
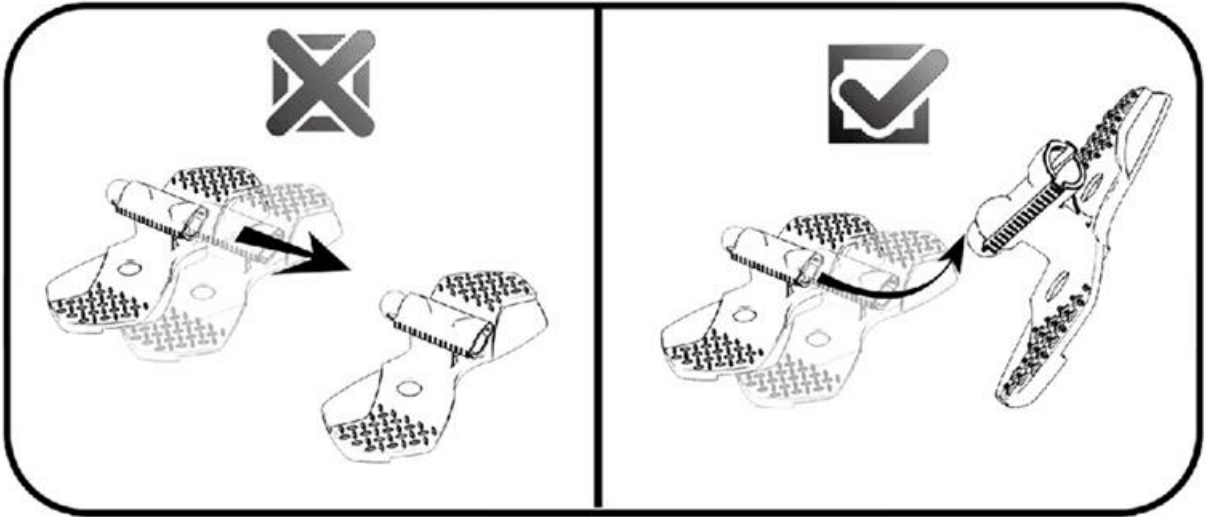



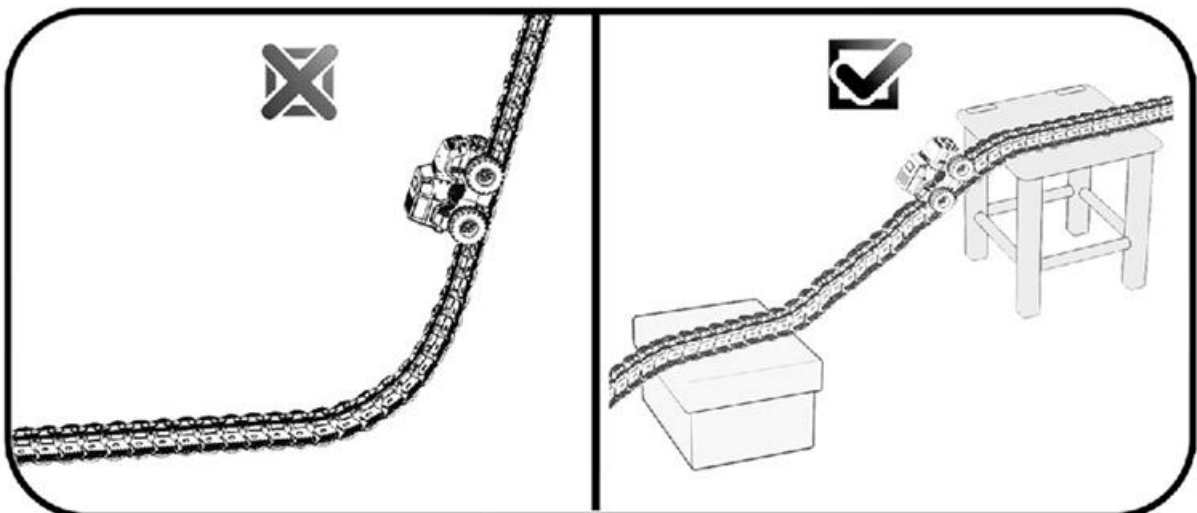
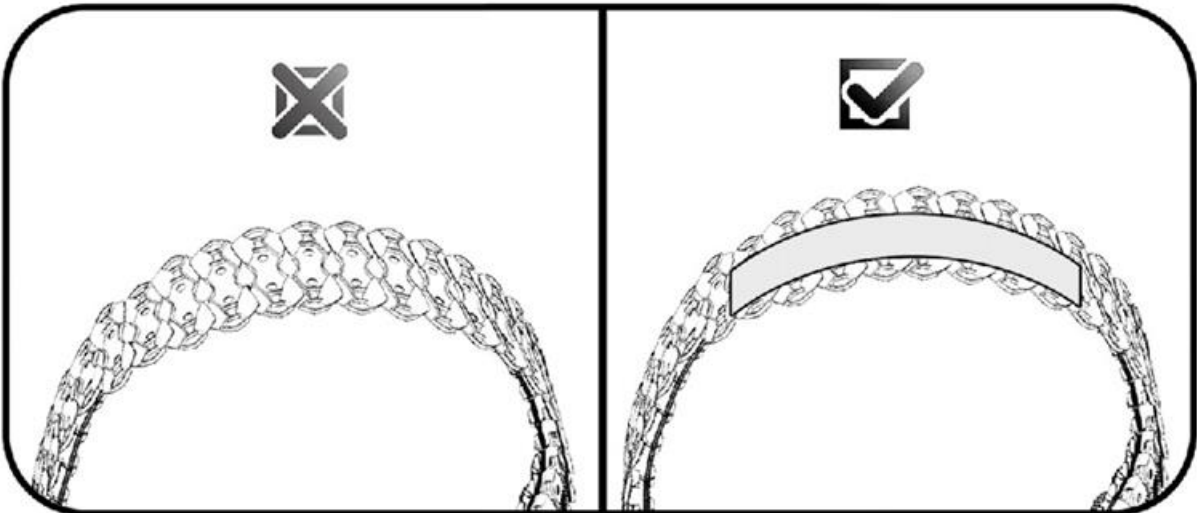
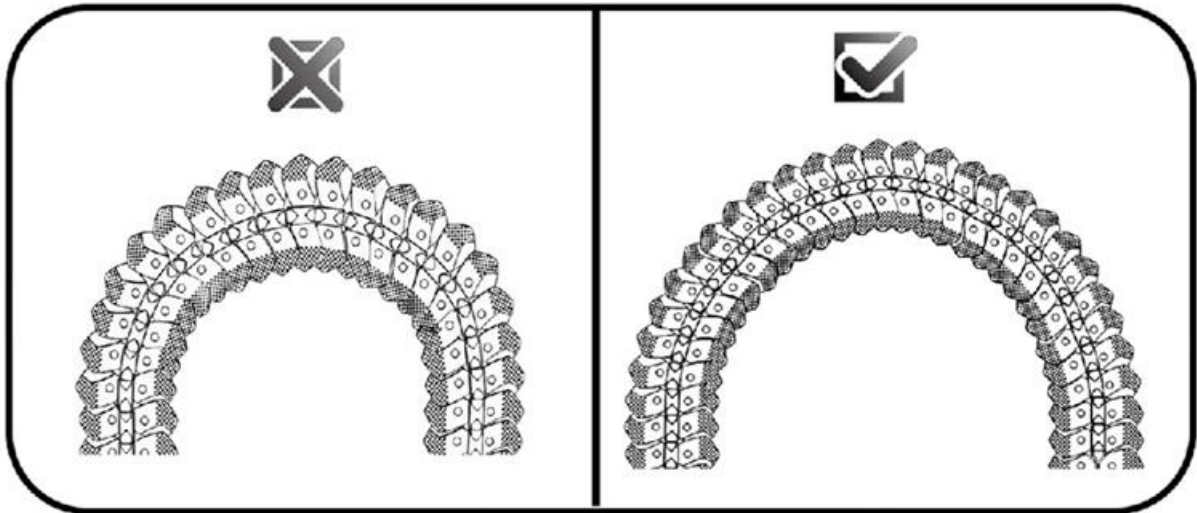

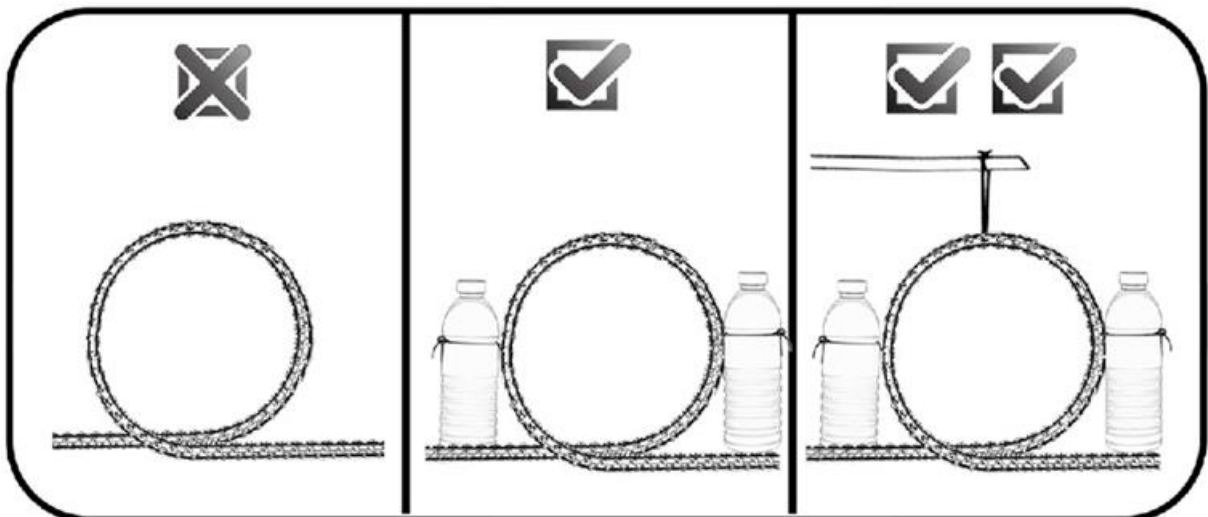
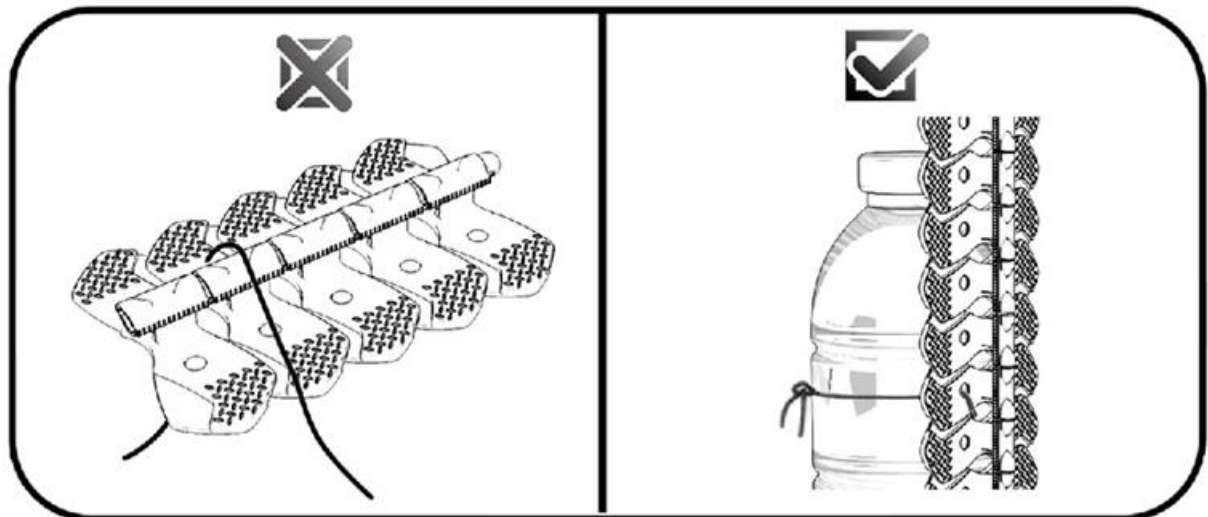
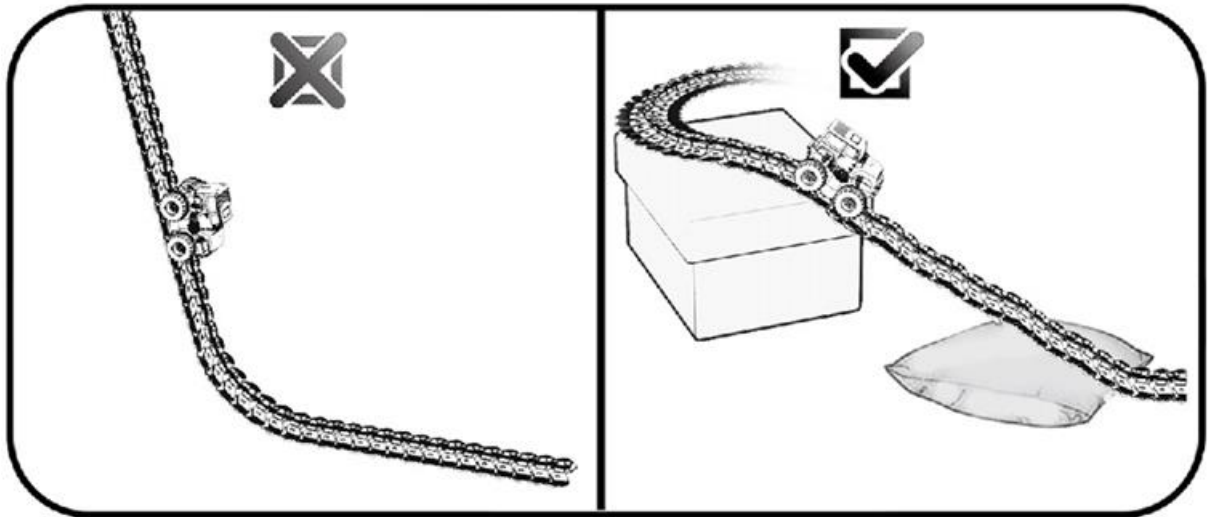

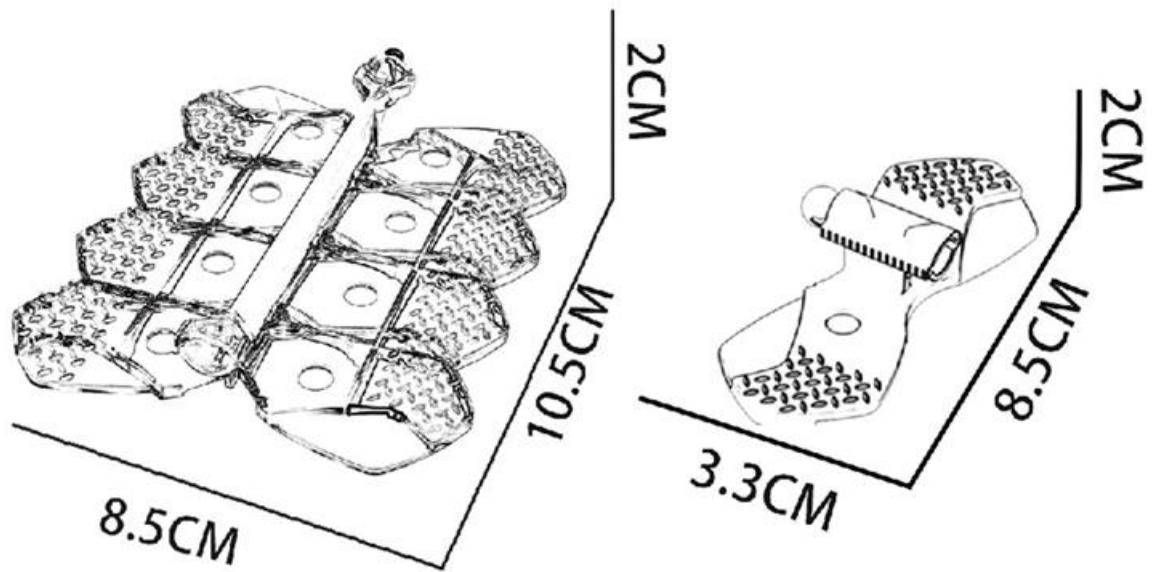

#### NAVODILA ZA RECIKLIRANJE IN ODLAGANJE:



Ta oznaka pomeni, da izdelka ni dovoljeno odvreči med gospodinjske odpadke po vsej EU. Da bi preprečili potencialno škodo okolju ali človeškemu zdravju zaradi nekontroliranega odlaganja odpadkov. Reciklirajte odgovorno za spodbujanje trajnostne rabe materialnih virov. Če želite vrniti uporabljen izdelek, uporabite sistem za oddajo in zbiranje, ali pa stopite v stik z trgovcem, pri katerem ste izdelek kupili. Trgovina lahko sprejme izdelek za okolju prijazno recikliranje.



Izjava proizvajalca, da izdelek izpolnjuje zahteve ustreznih direktiv EU.



## HR: LUMITRACK – KORISNIČKI PRIRUČNIK

### PUNJENJE BATERIJE

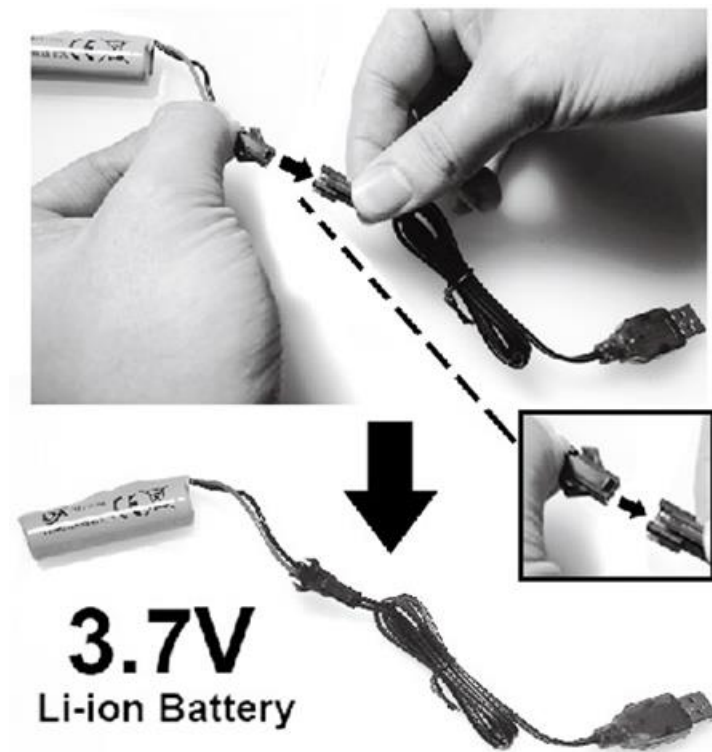

U pakiranju proizvoda nalaze se 3,7V Li-ionska baterija i punjač.

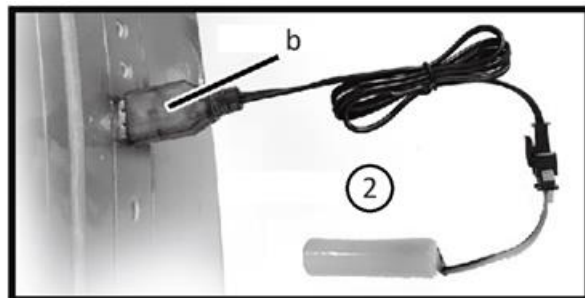
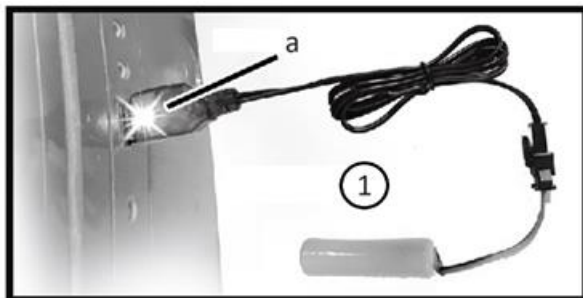

1. Punjenje baterije
  - a) Svjetle lampice
2. Baterija potpuno napunjena
  - b) Nema svjetlosti

Kada je baterija potpuno napunjena, proizvod svijetli 70-90 minuta.

UPUTE ZA MONTAŽU AUTOMOBILA

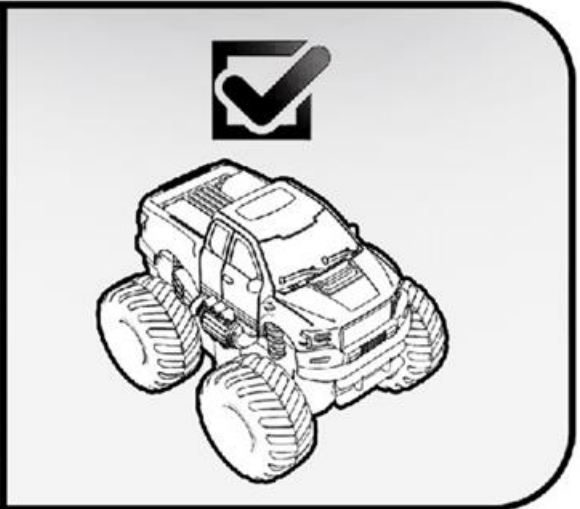
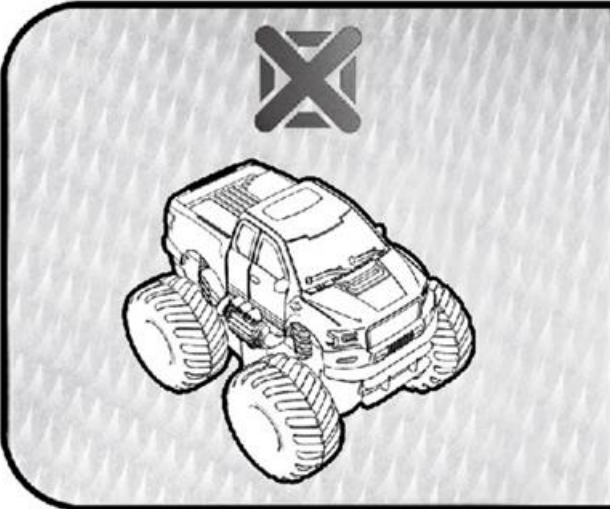
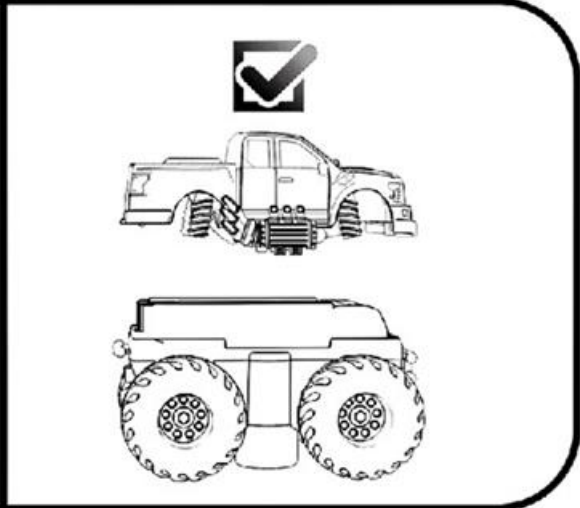
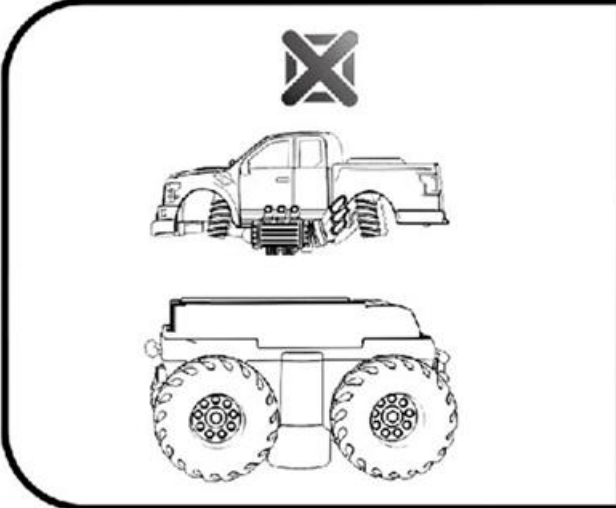
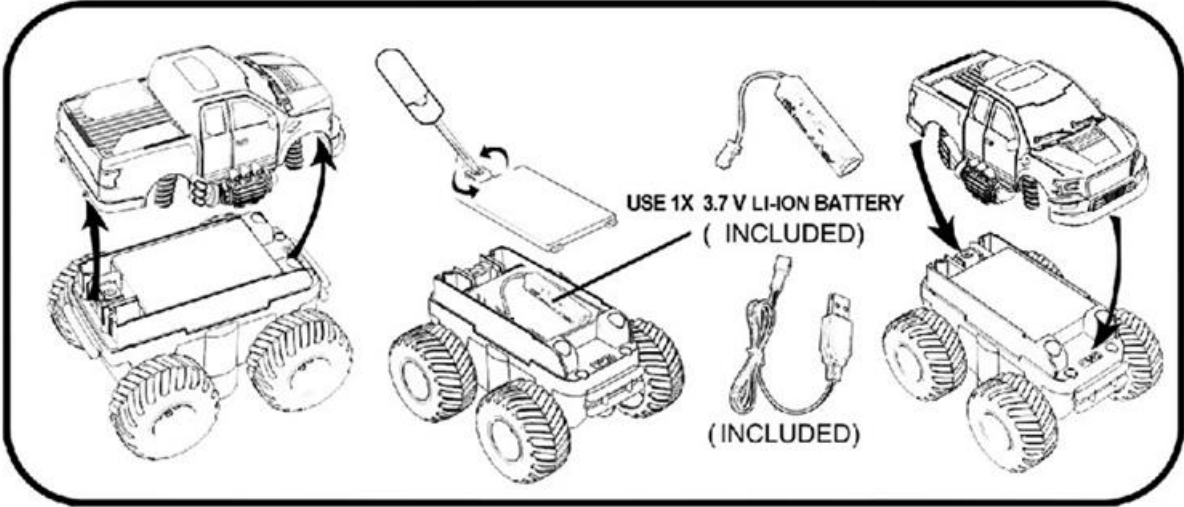

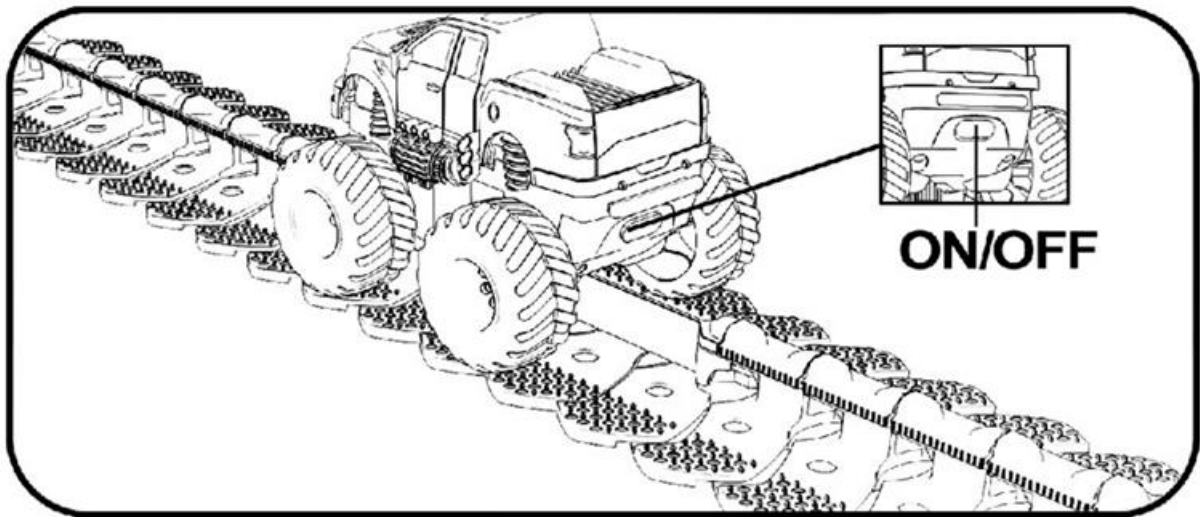
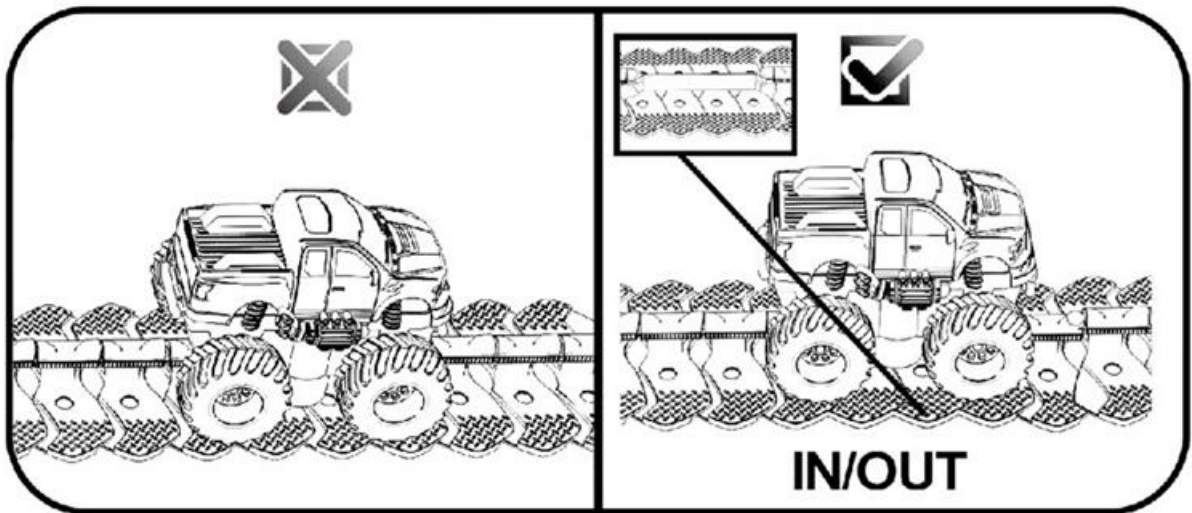

SMJEŠTAJ OZNAKA: AUTOMOBIL 1









SMJEŠTAJ OZNAKA: AUTOMOBIL 2

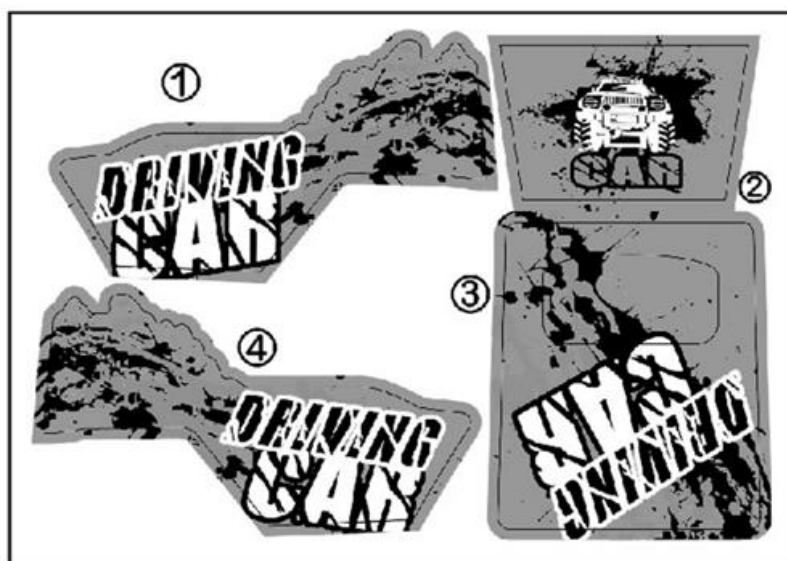



### MONTAŽA STAZA

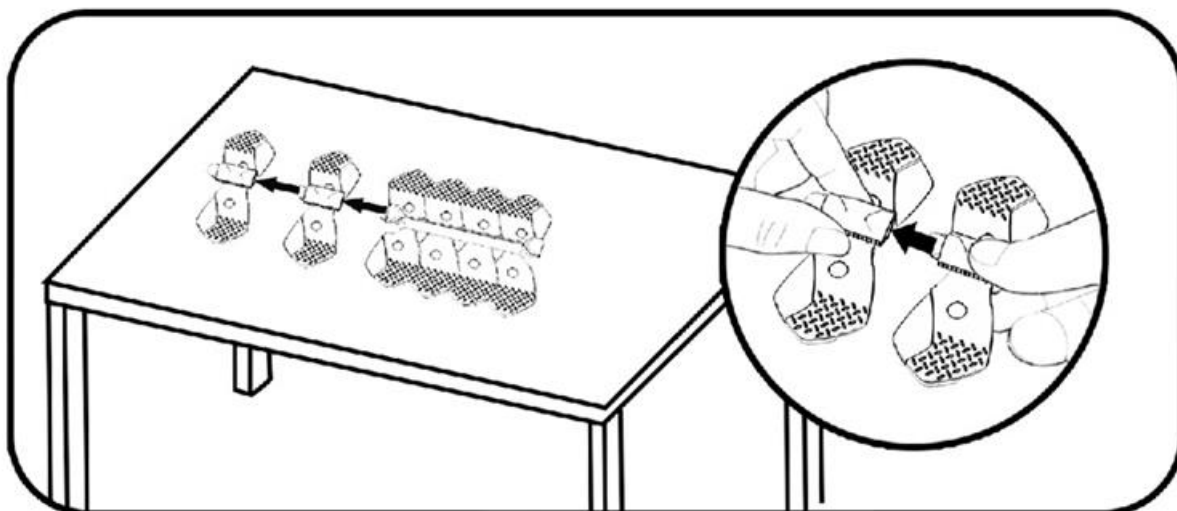

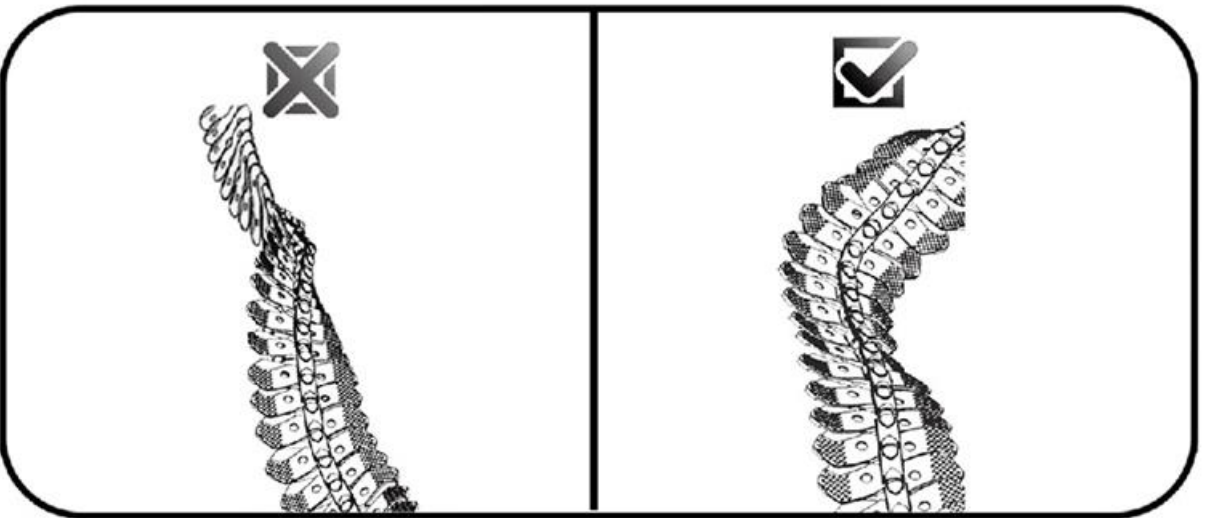
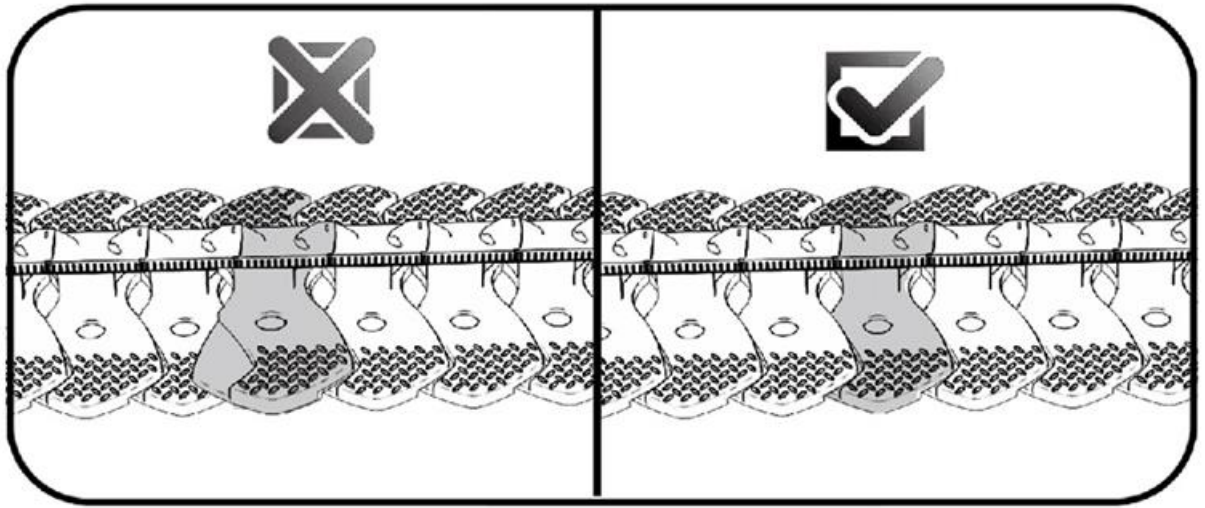
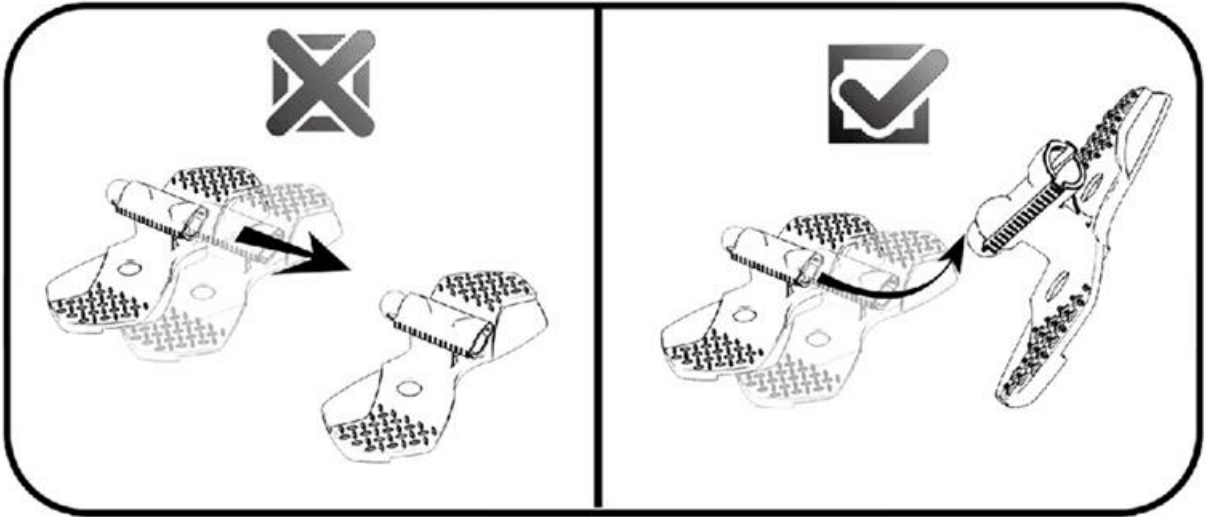

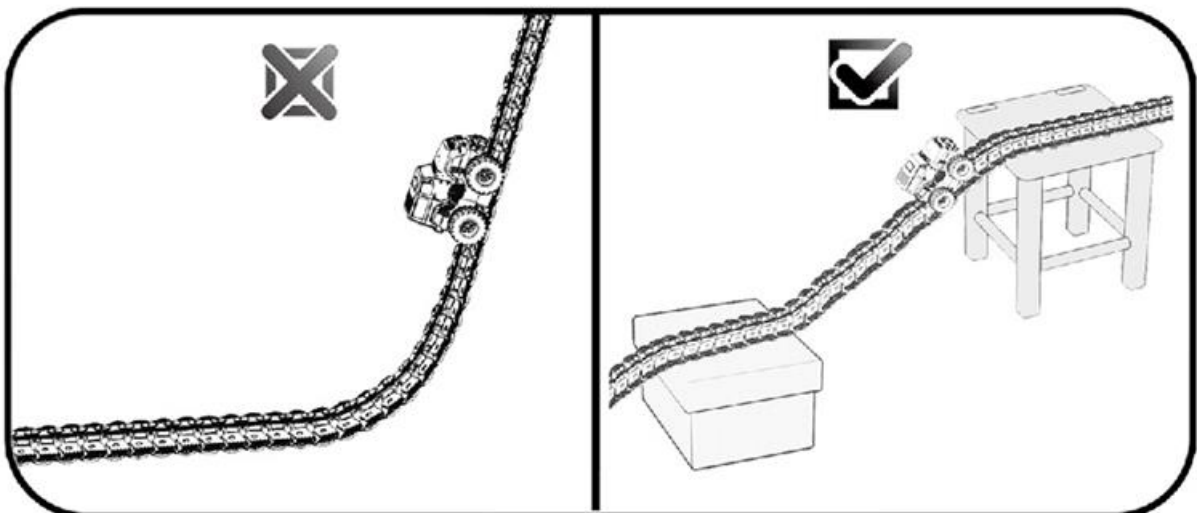
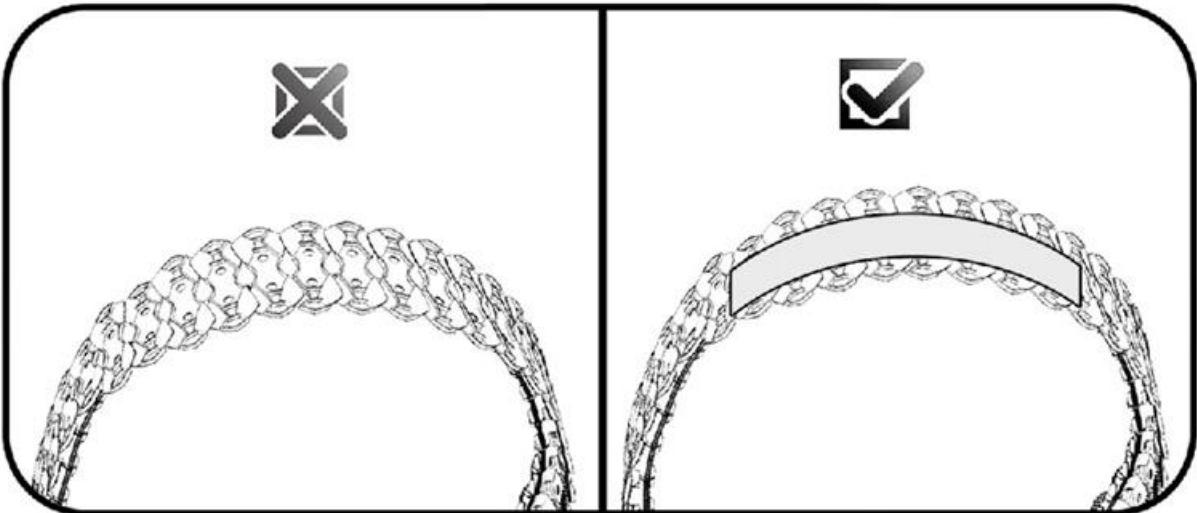
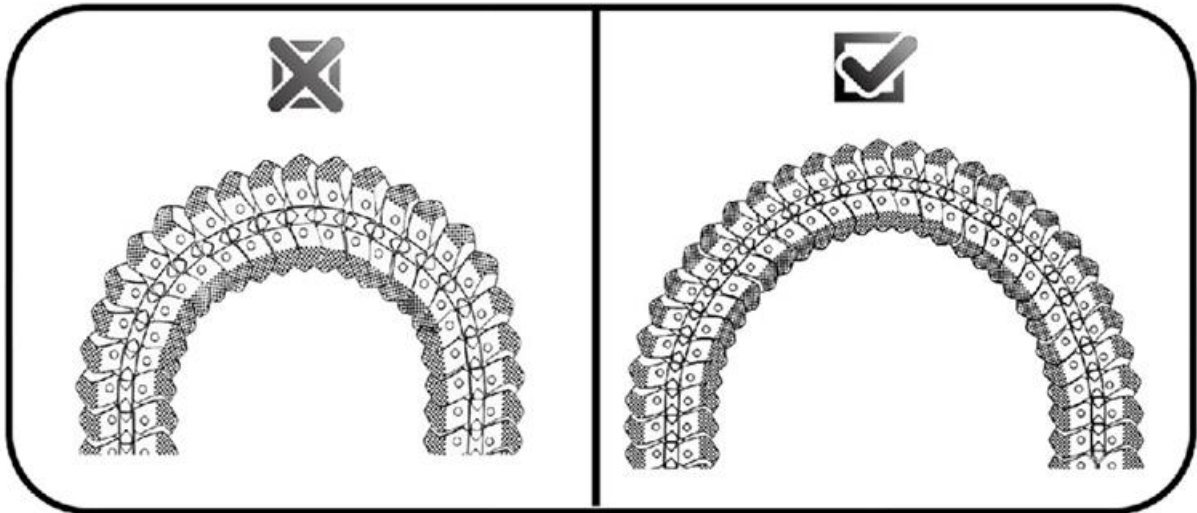



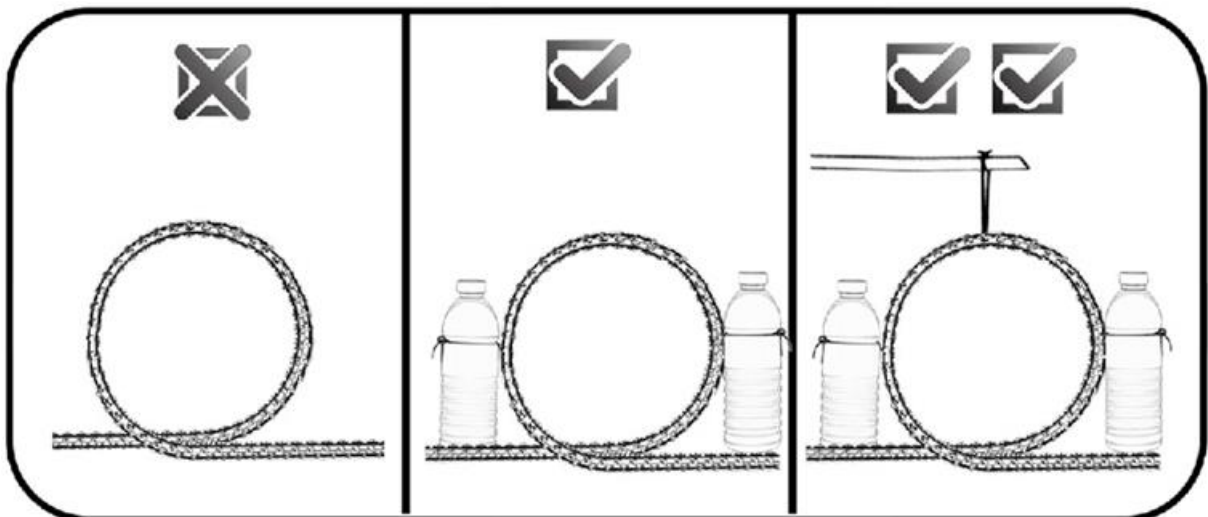
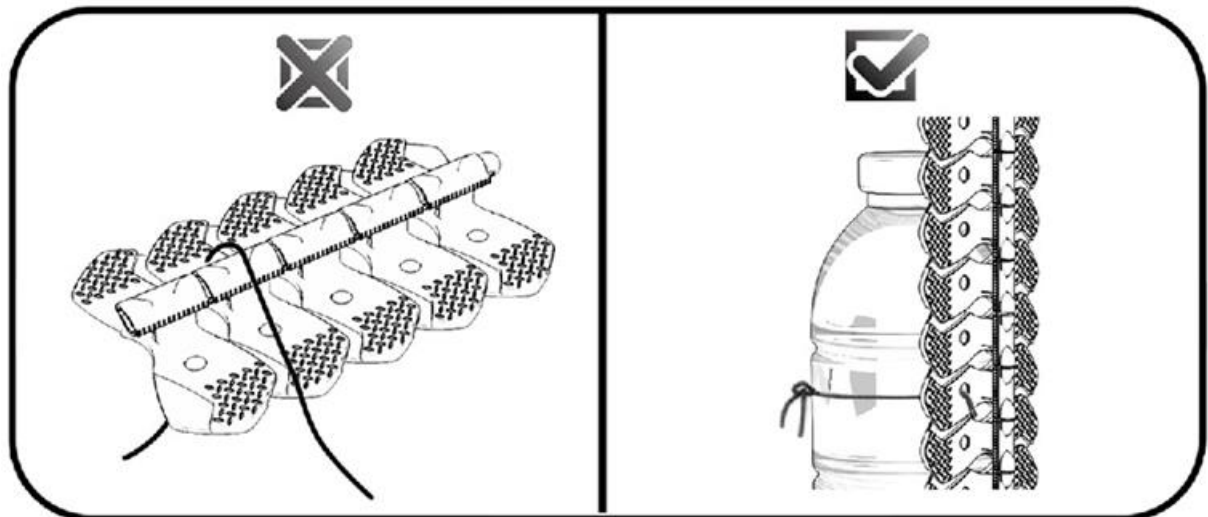
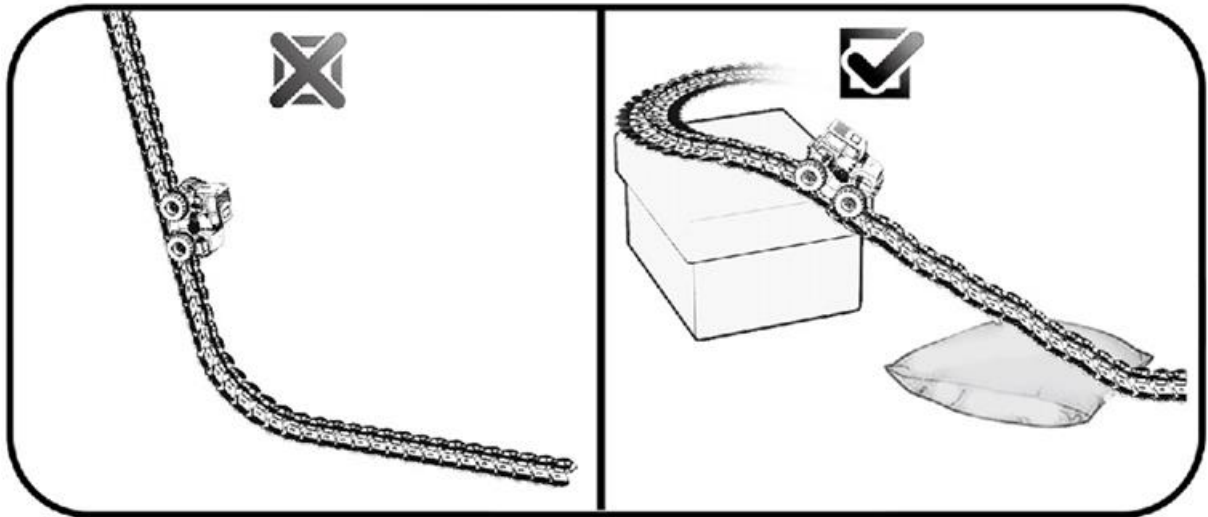

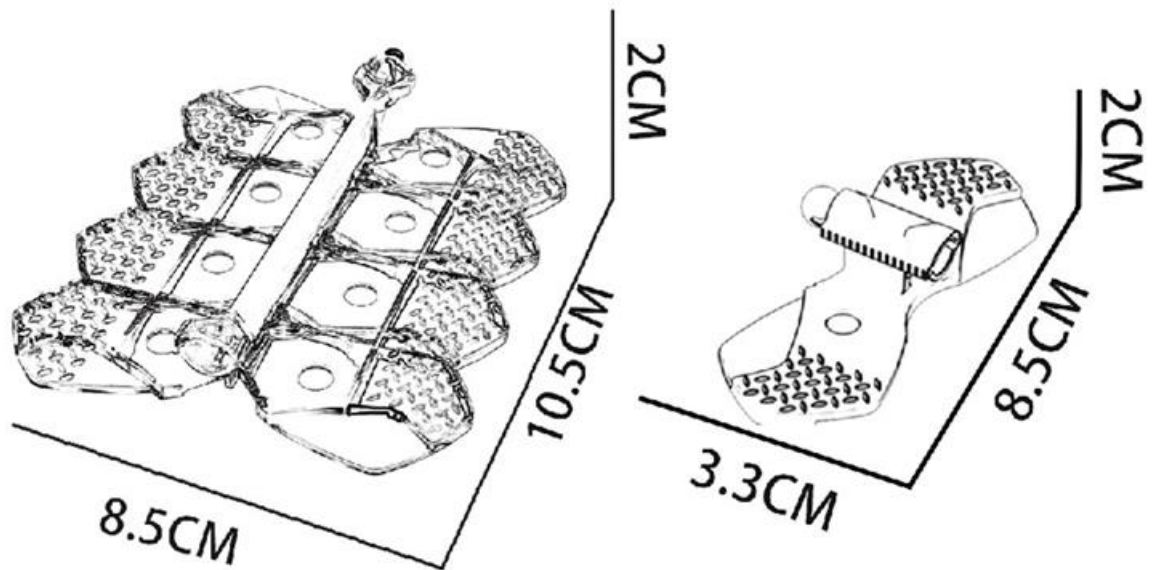

#### UPUTE ZA RECIKLAŽU I ODLAGANJE:



Ova oznaka znači da se proizvod ne smije odbaciti kao ostatak kućanstva u cijeloj EU. Kako biste spriječili moguću štetu okolišu ili ljudskom zdravlju od nekontroliranog odlaganja otpada. Reciklirajte odgovorno kako biste potaknuli održivu uporabu materijalnih resursa. Ako želite vratiti korišteni uređaj, koristite sustav za predaju i prikupljanje, ili kontaktirajte prodavača od kojeg ste kupili proizvod. Prodavač može prihvatiti proizvod za ekološki sigurno recikliranje.



Izjava proizvođača da proizvod zadovoljava zahtjeve odgovarajućih direktiva EU.

## IT: LUMITRACK - MANUALE D'USO

### CARICA DELLA BATTERIA

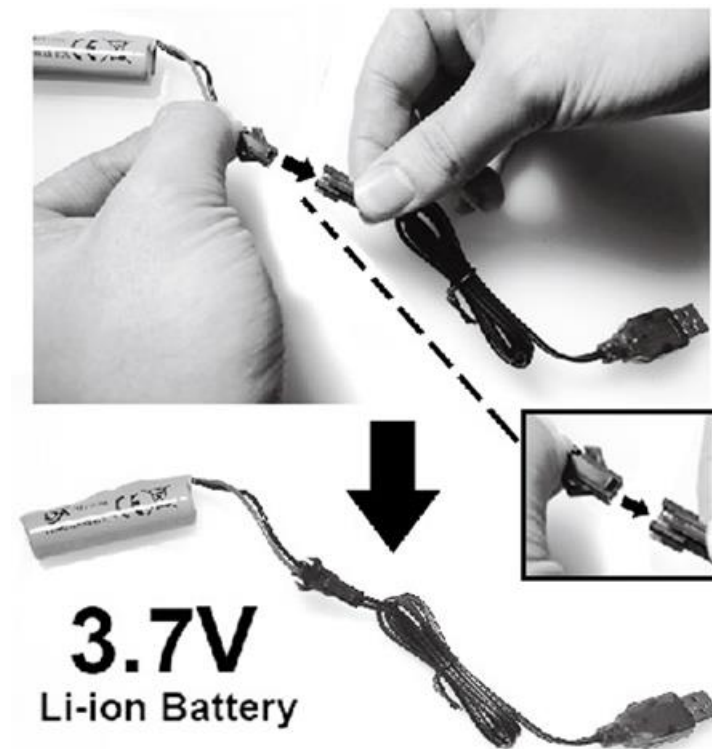

La batteria agli ioni di litio da 3,7 V e il caricabatterie sono inclusi nella confezione del prodotto.

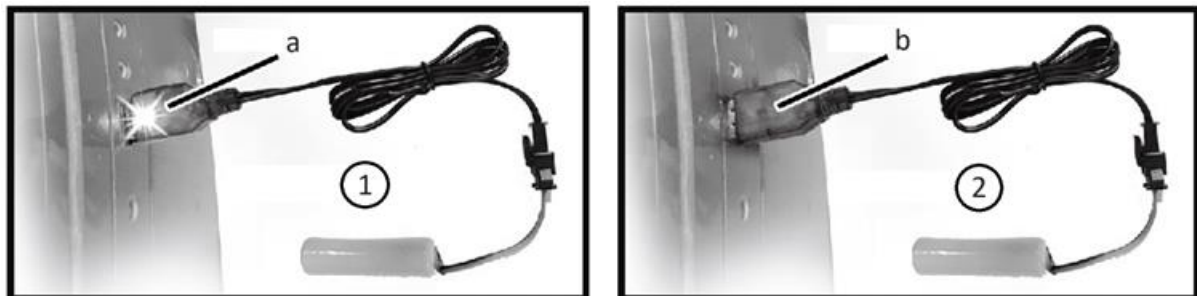

1. Ricarica della batteria

a) Luci luminose

2. Batteria completamente carica

b) Nessuna luce

Quando è completamente carica, il prodotto brilla per 70-90 minuti.

ISTRUZIONI PER IL MONTAGGIO DELL'AUTO

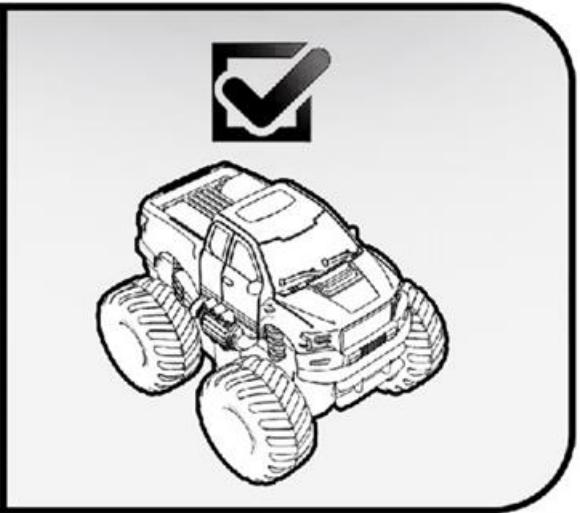
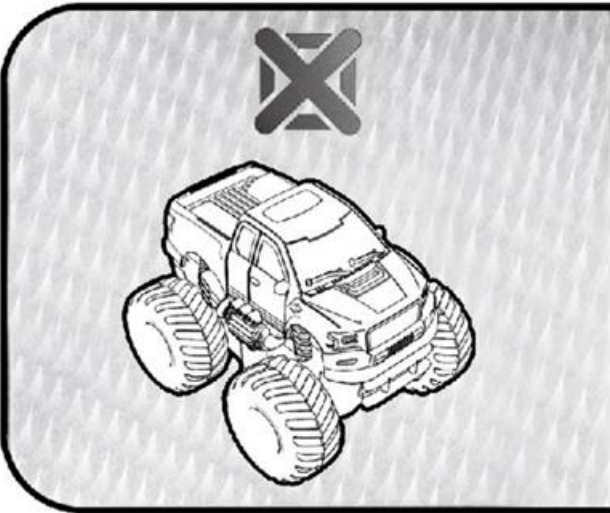
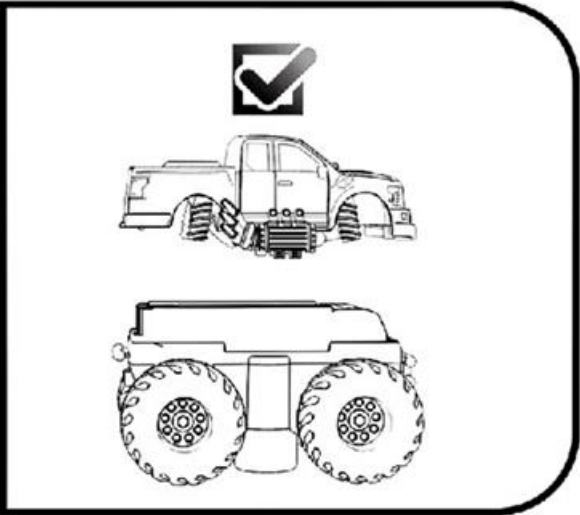
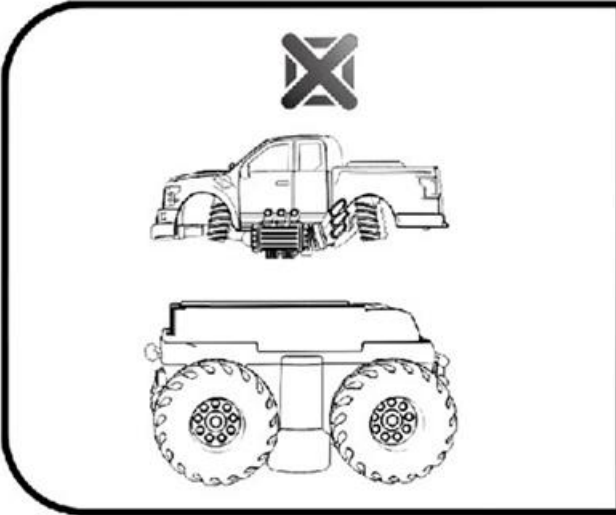
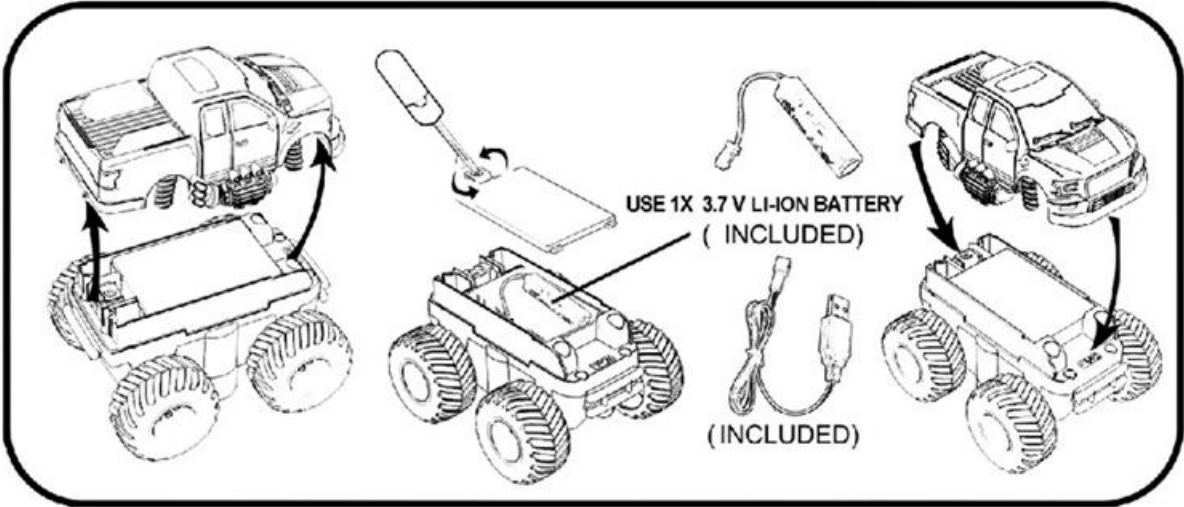



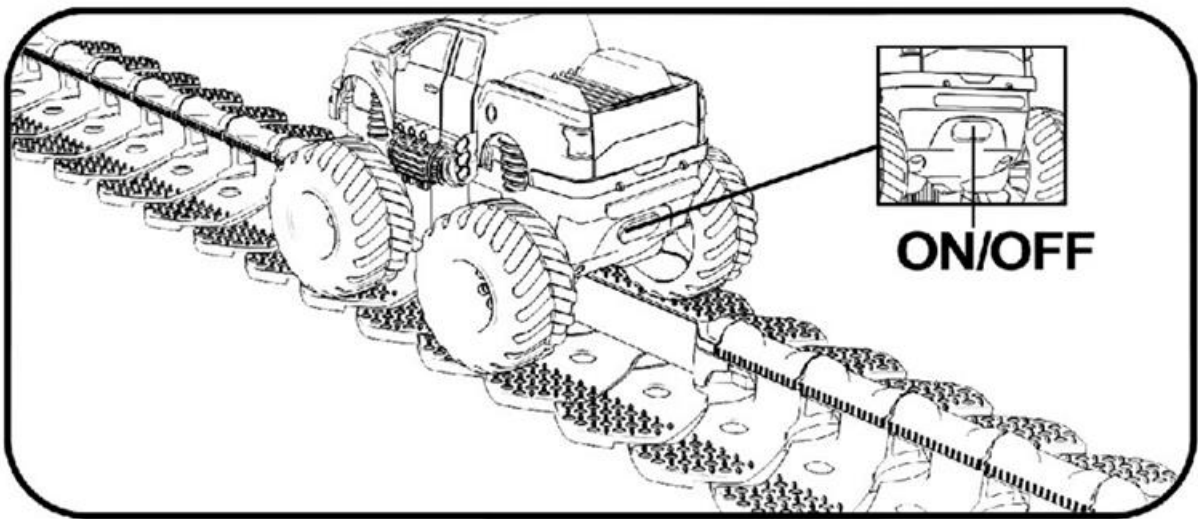
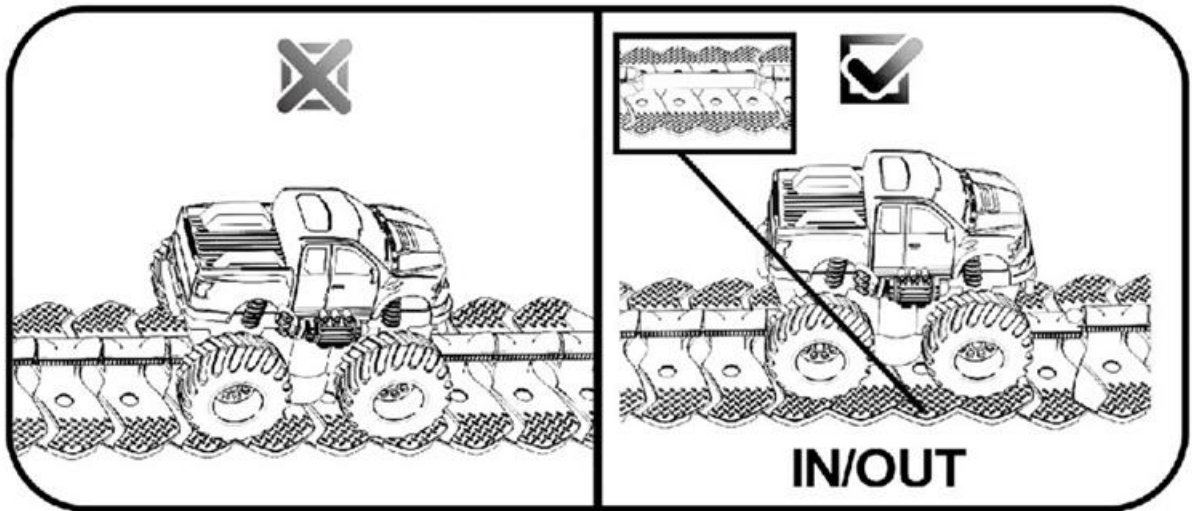

POSIZIONAMENTO DELLE ETICHETTE: AUTO 1





POSIZIONAMENTO DELLE ETICHETTE: AUTO 2

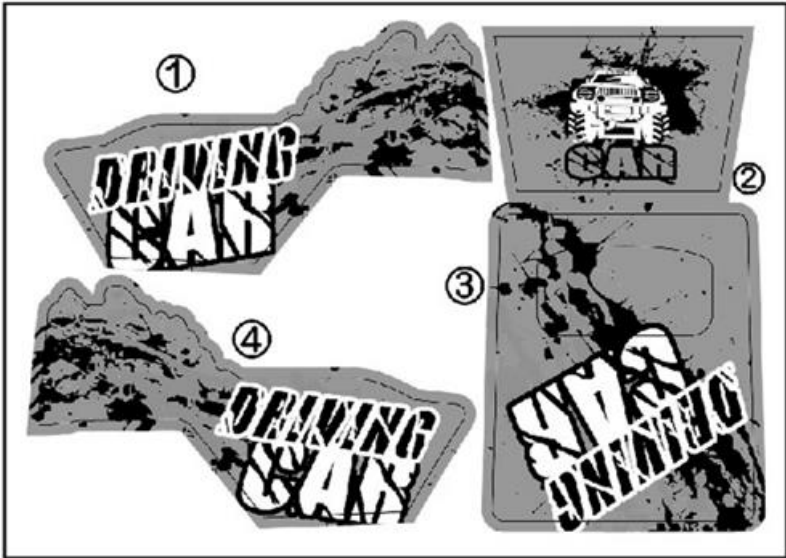





#### ASSEMBLAGGIO DEI BINARI

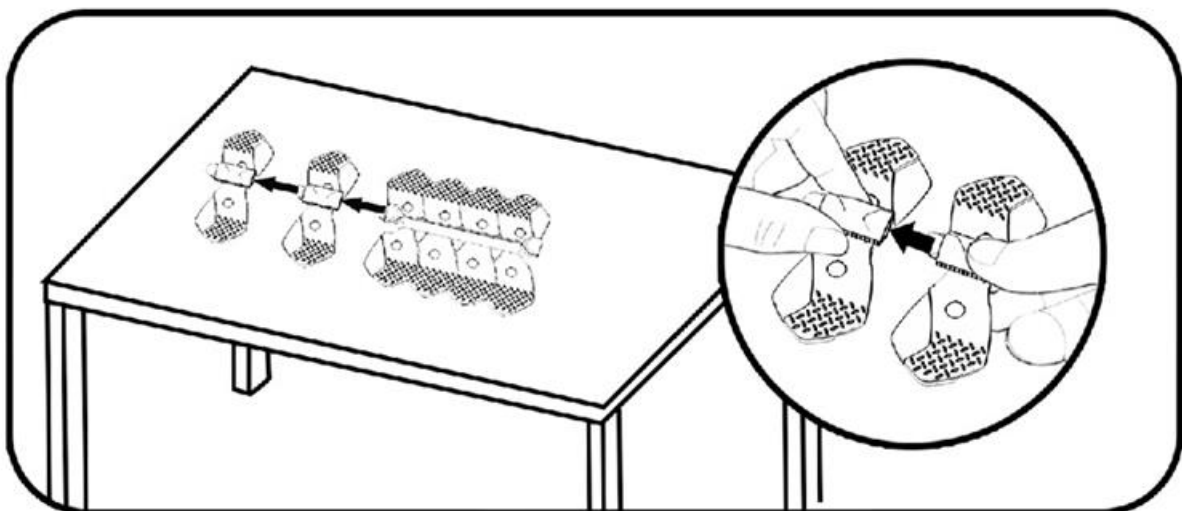



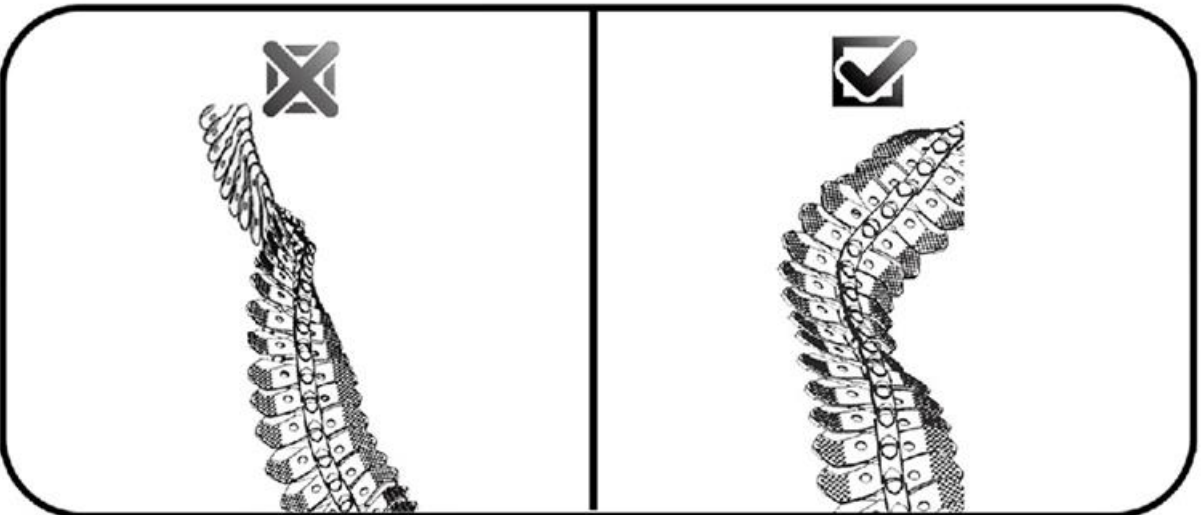
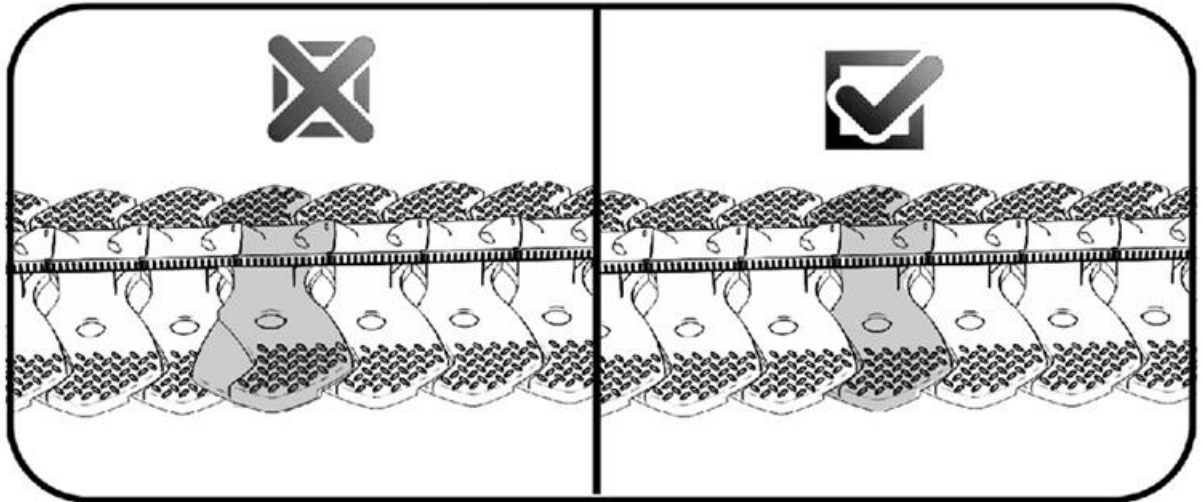
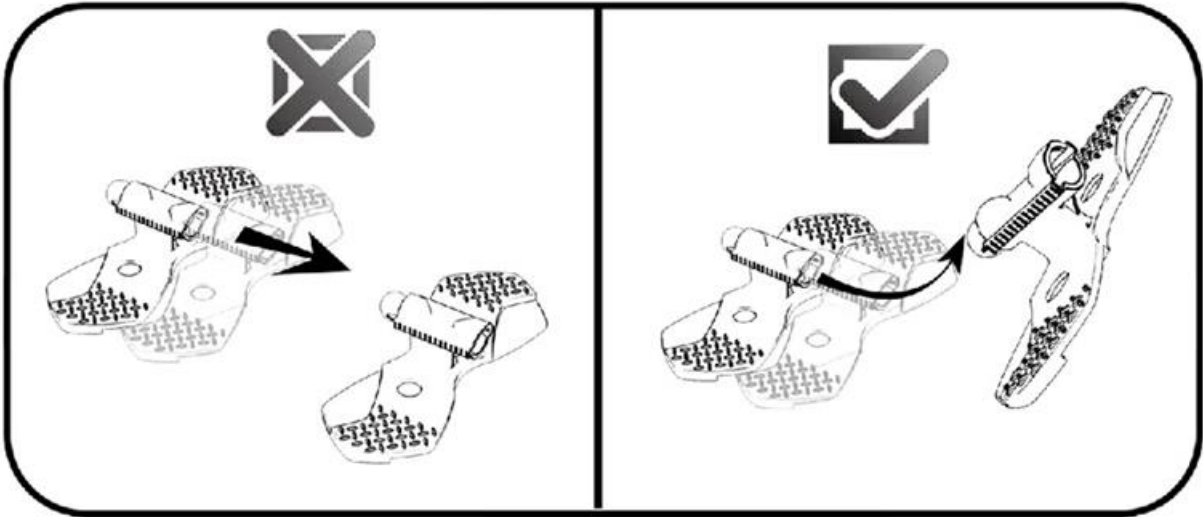

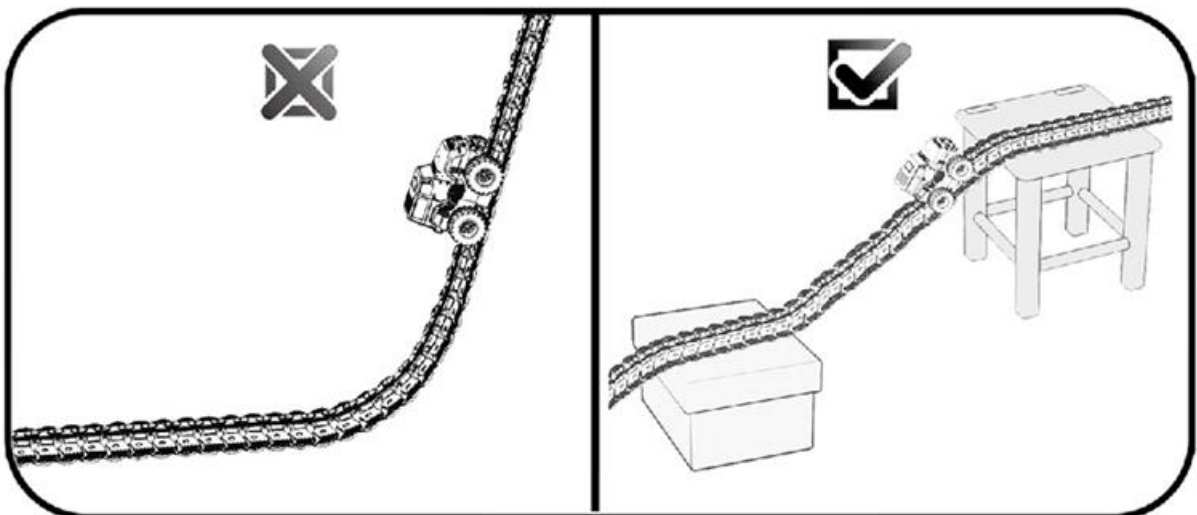
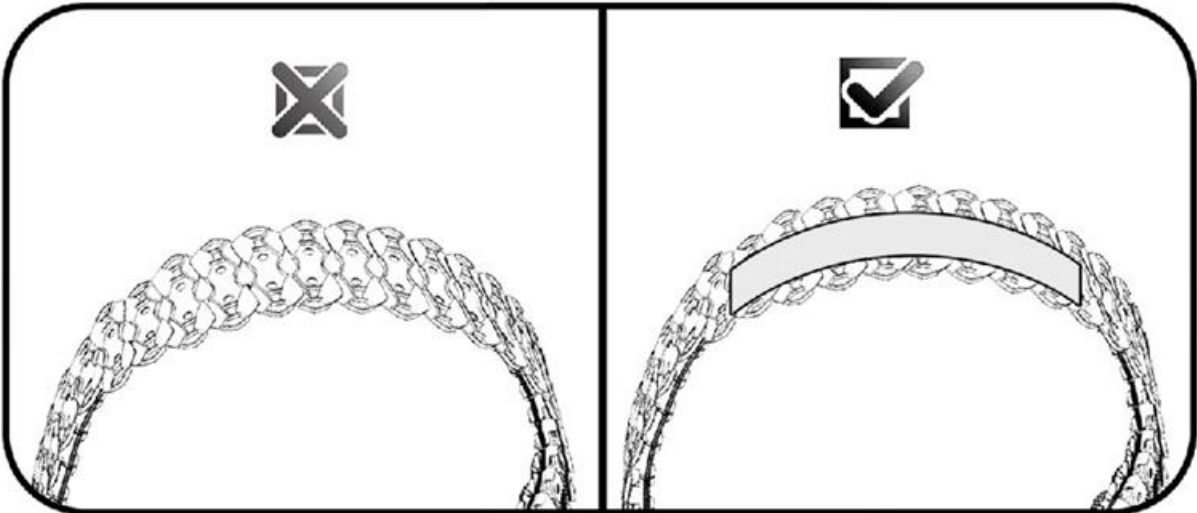
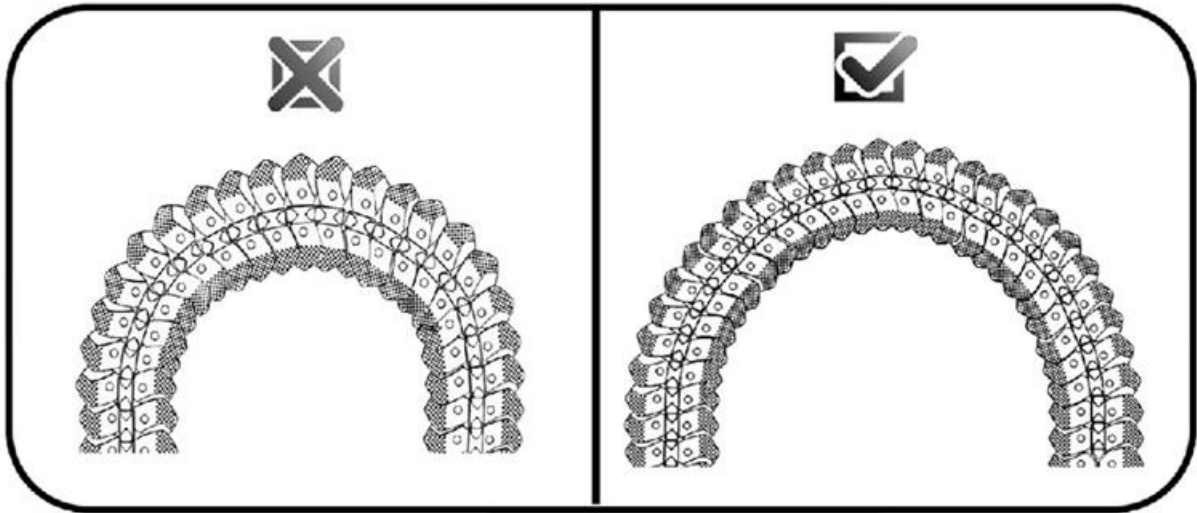

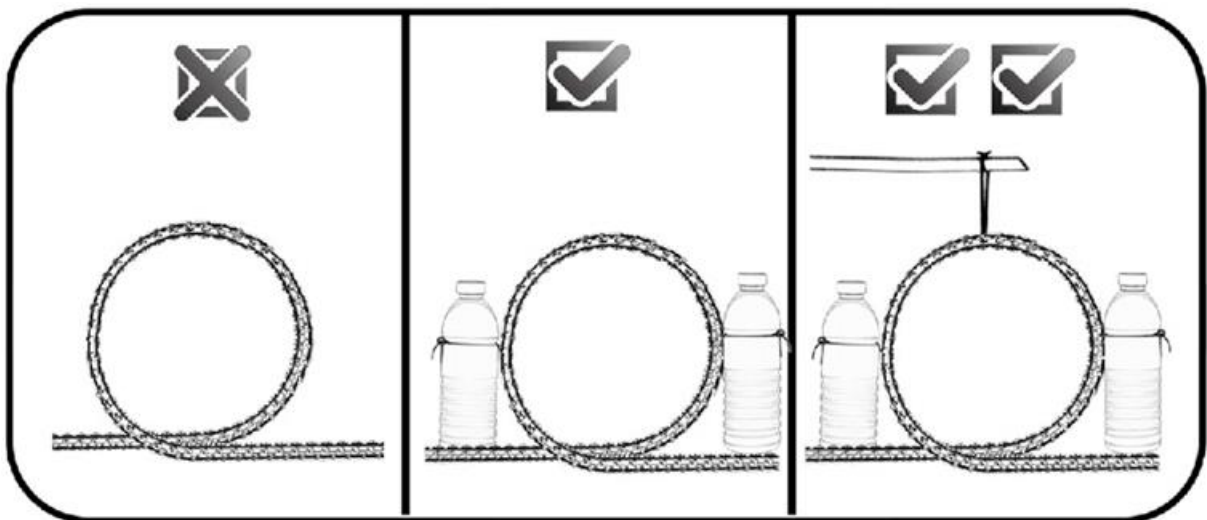
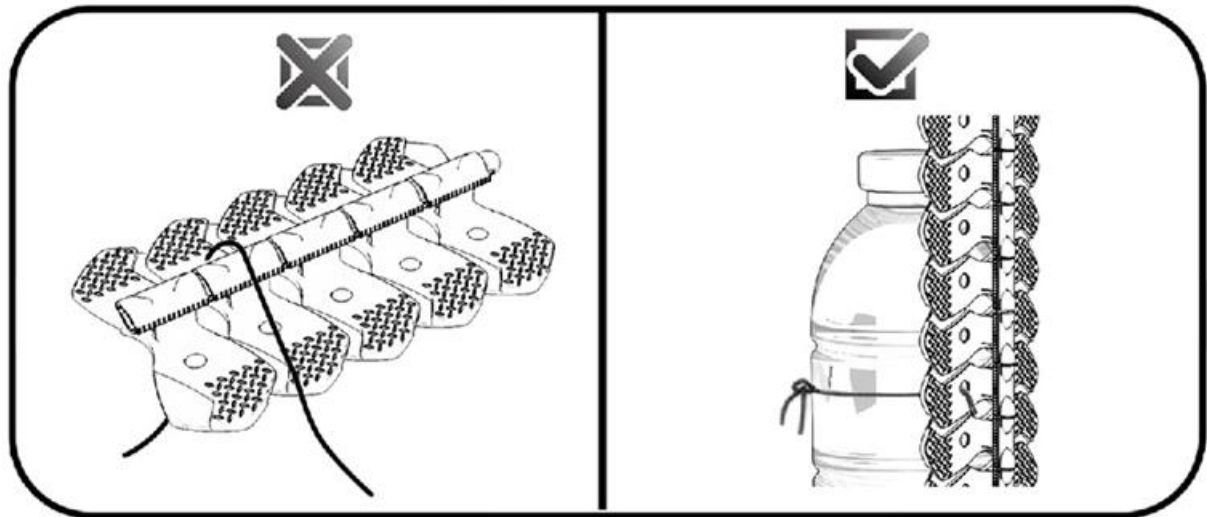
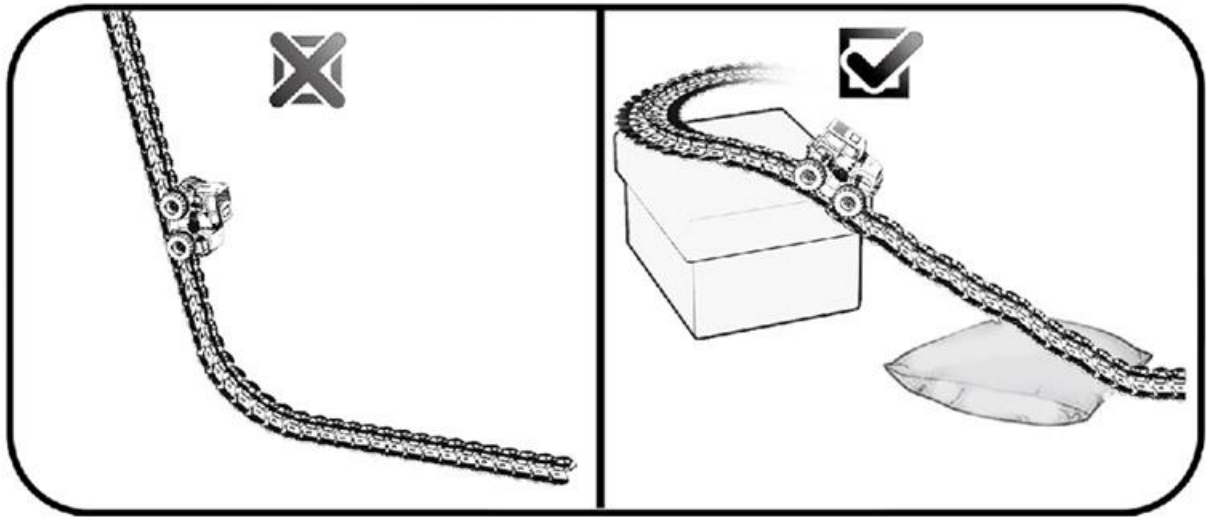

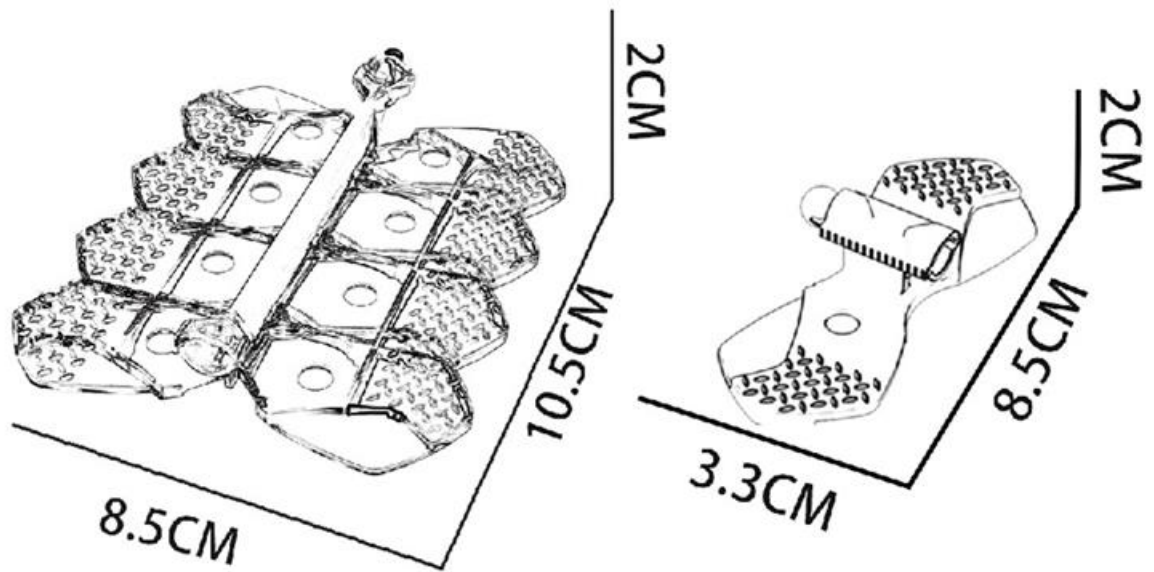

#### ISTRUZIONI PER IL RICICLAGGIO E LO SMALTIMENTO:



Questa etichetta indica che il prodotto non può essere smaltito come altri rifiuti domestici in tutta l'Unione Europea. Per prevenire possibili danni all'ambiente o alla salute umana derivanti da uno smaltimento non controllato dei rifiuti. Ricicla responsabilmente per promuovere l'uso sostenibile delle risorse materiali. Se desideri restituire un dispositivo usato, utilizza il sistema di raccolta o contatta il rivenditore presso il quale hai acquistato il prodotto. Il rivenditore può accettare il prodotto per un riciclaggio ecologicamente sicuro.



Una dichiarazione del produttore che attesta che il prodotto è conforme ai requisiti delle direttive dell'UE applicabili.



## DE/AT: LUMITRACK - BENUTZERHANDBUCH

### AUFLADEN DES AKKUS

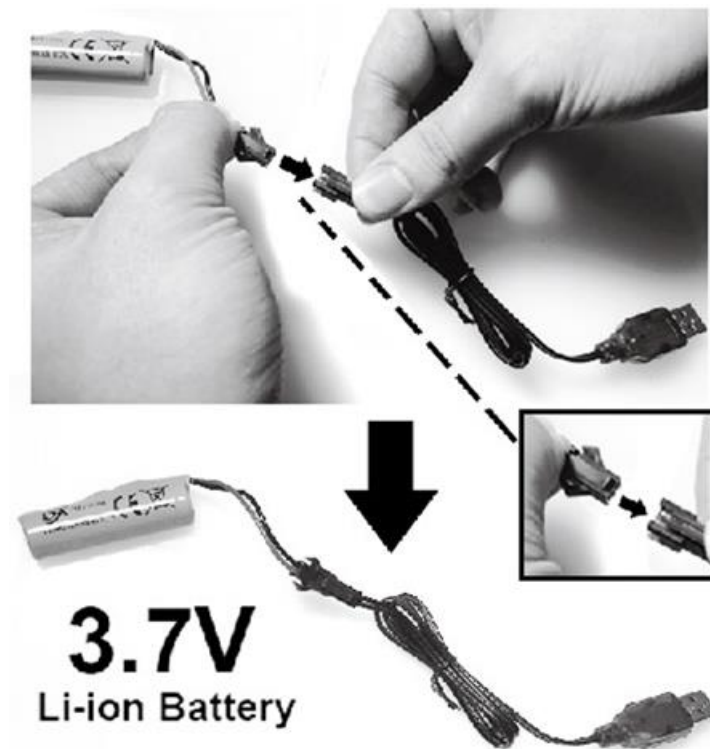

Der 3,7V Li-Ionen-Akku und das Ladegerät sind in der Produktverpackung enthalten.

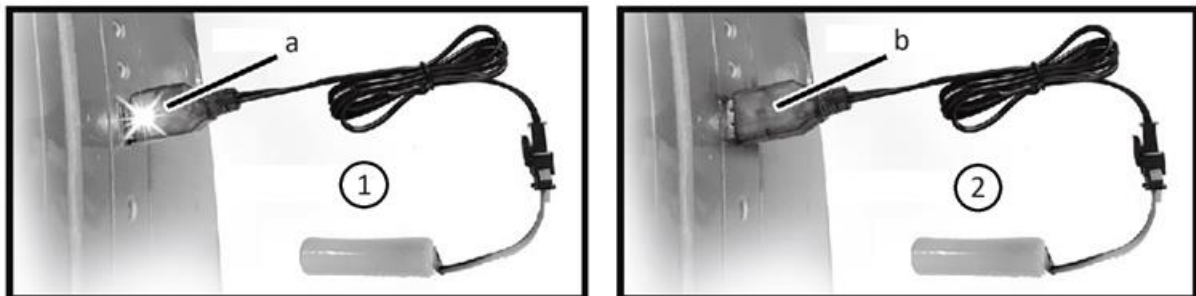

1. Aufladen des Akkus

a) Helle Lichter

2. Akku vollständig aufgeladen

b) Kein Licht

Wenn der Akku vollständig geladen ist, leuchtet das Produkt 70-90 Minuten lang.

AUTO MONTAGEANLEITUNG

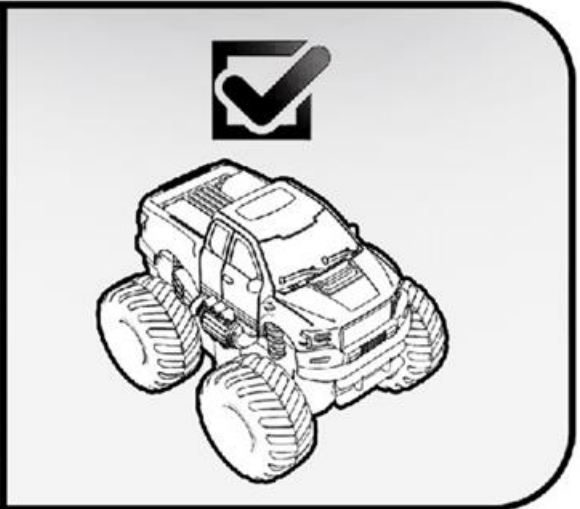
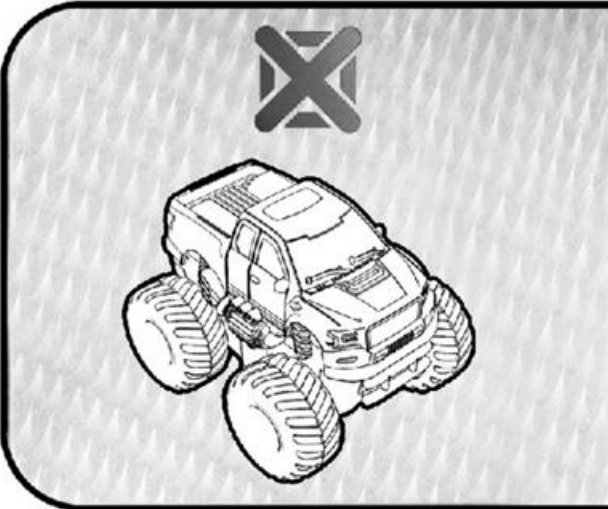
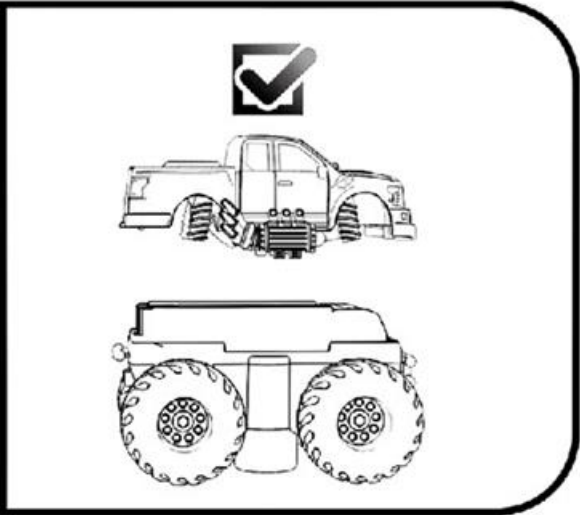
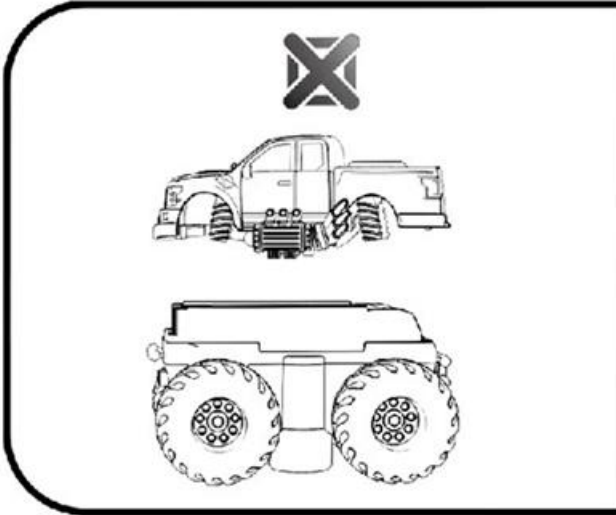
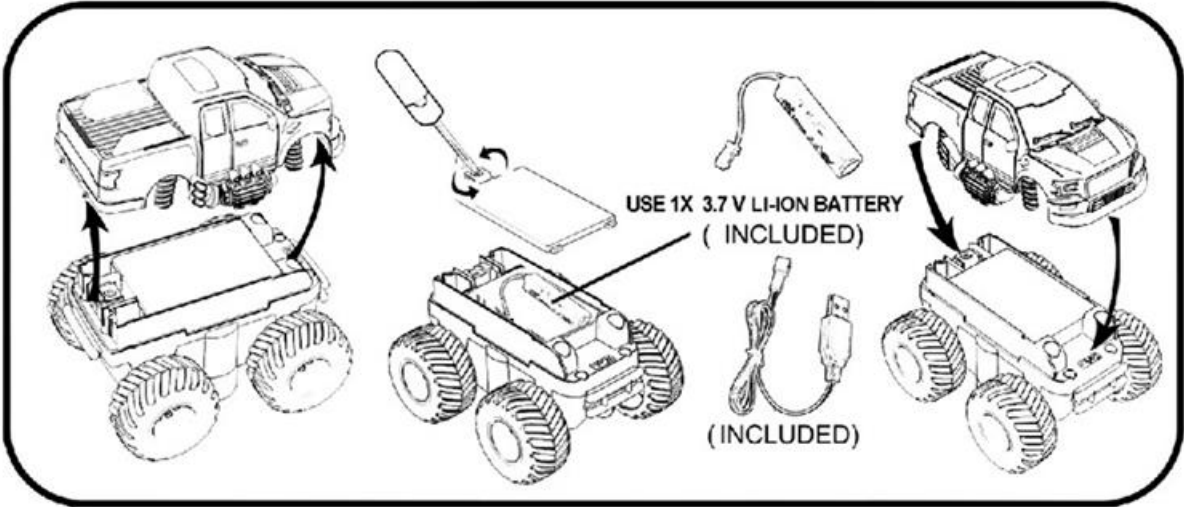

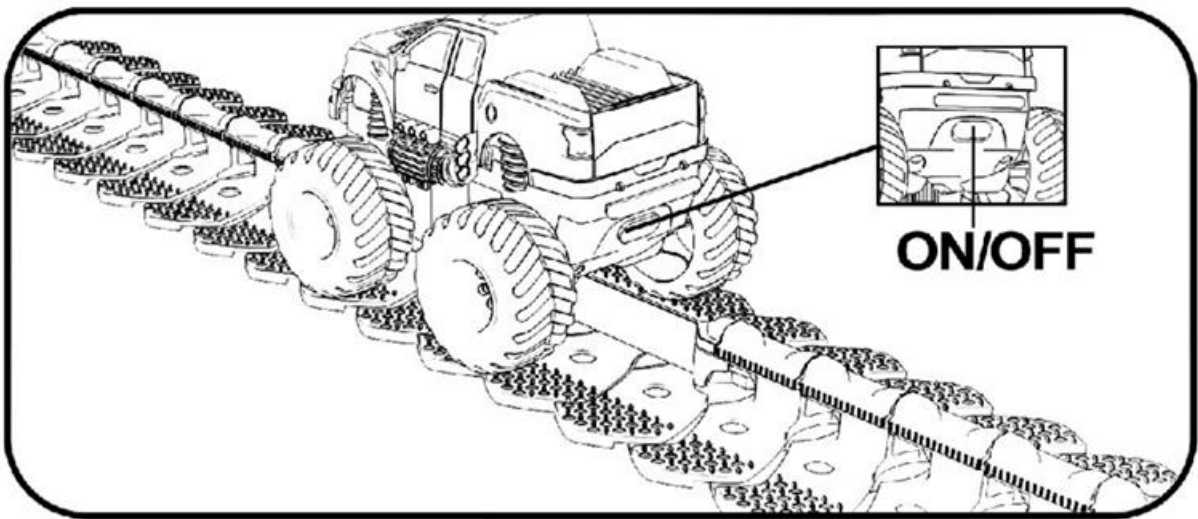
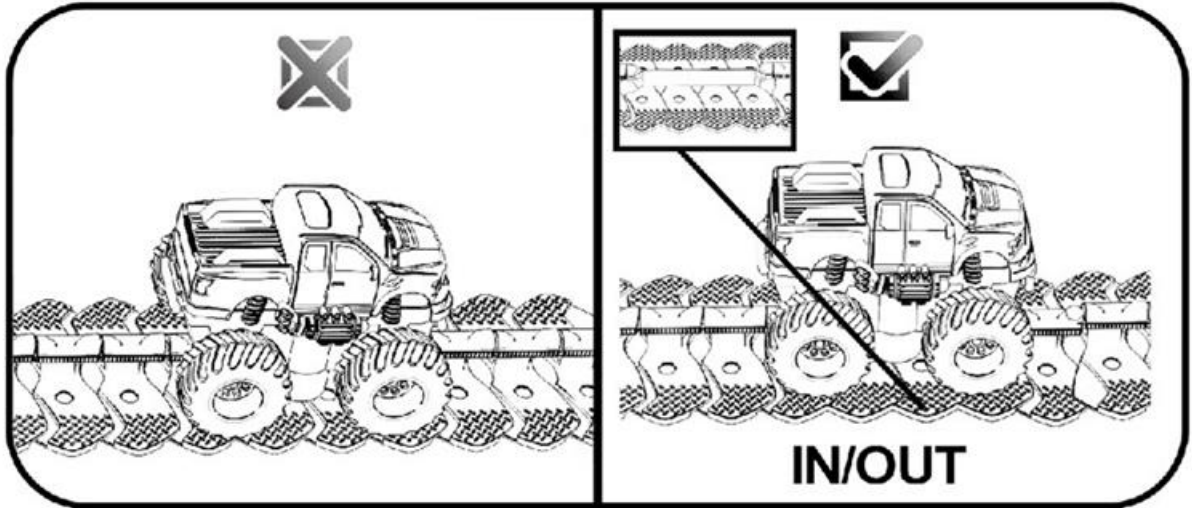

PLATZIERUNG DER AUFKLEBER: AUTO 1









PLATZIERUNG DER AUFKLEBER: WAGEN 2

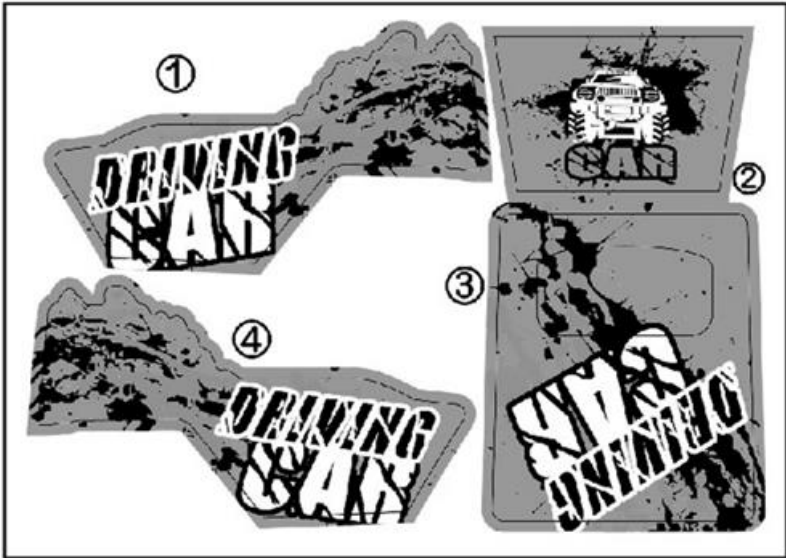



#### MONTAGE DER SCHIENEN

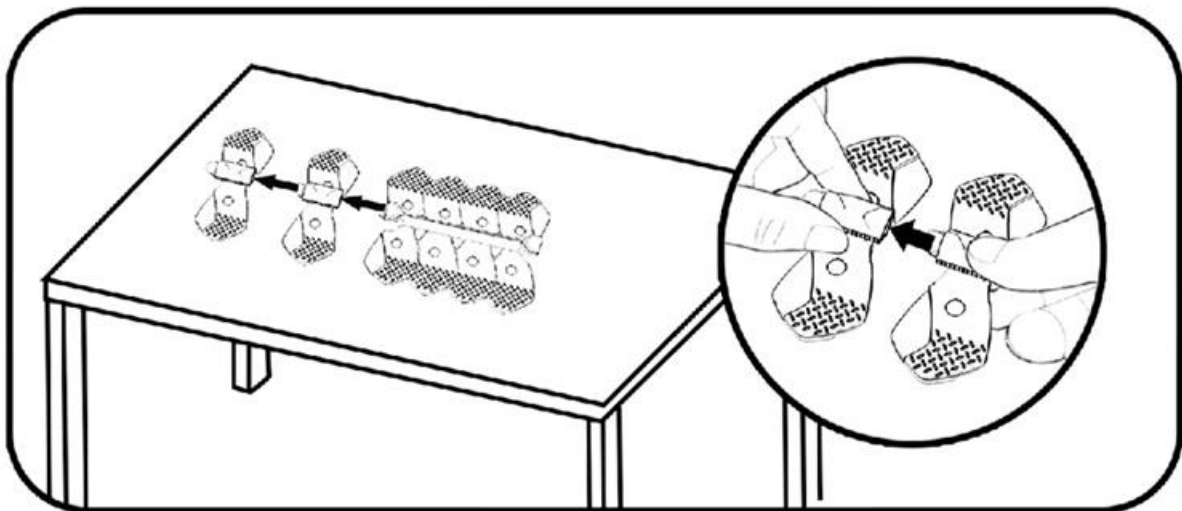

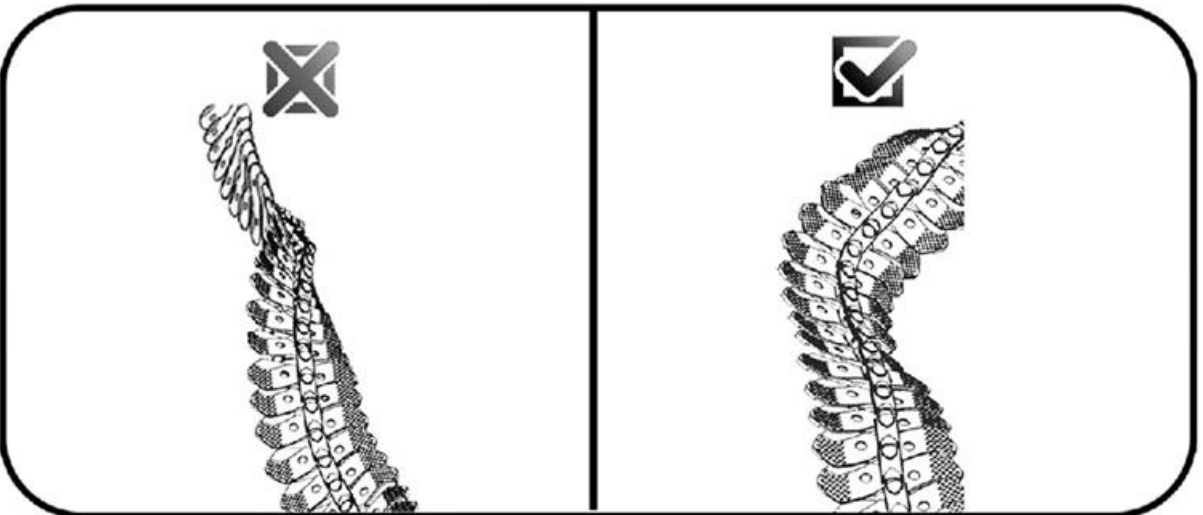
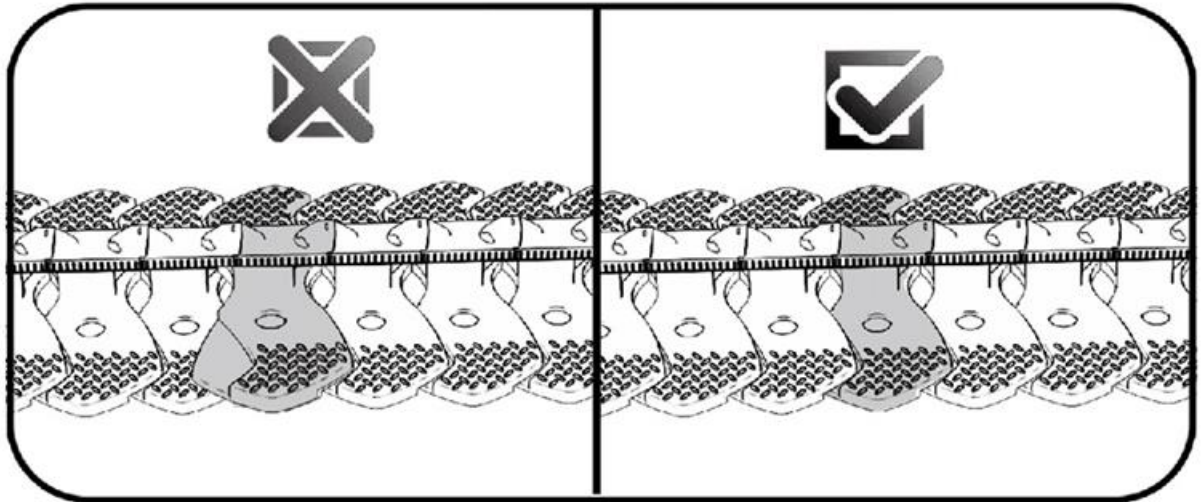
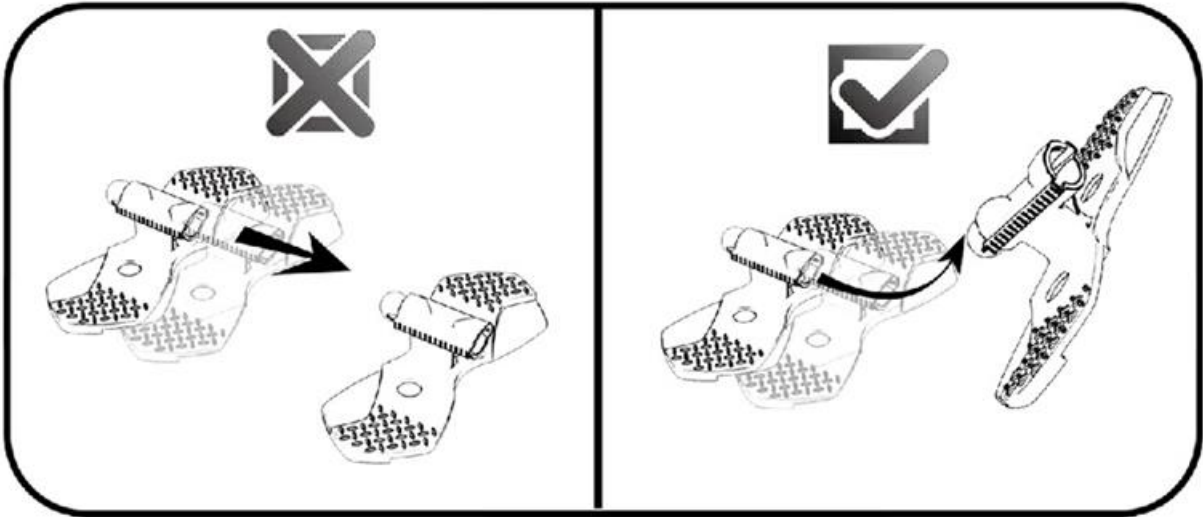

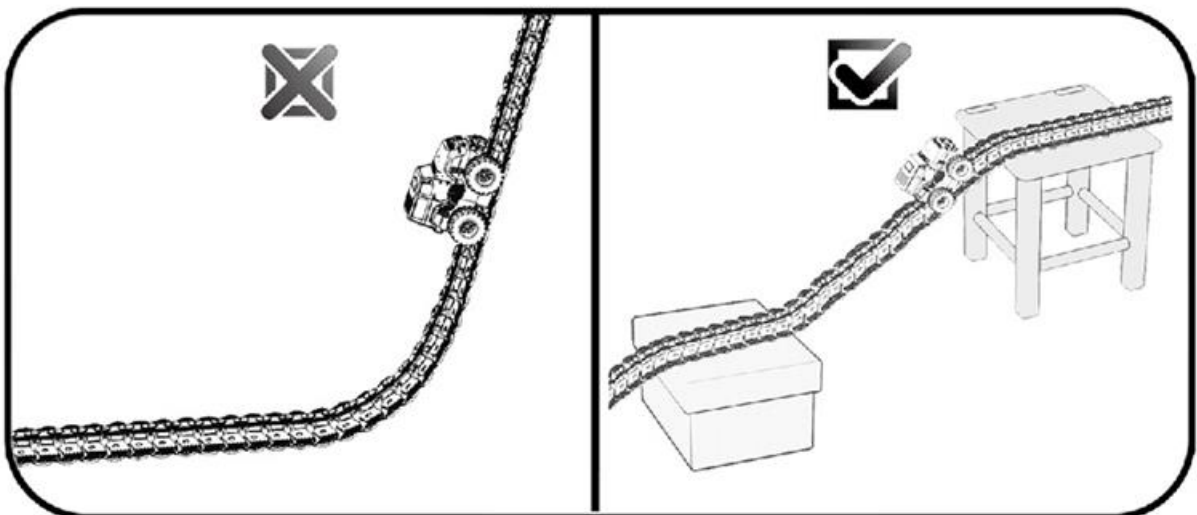
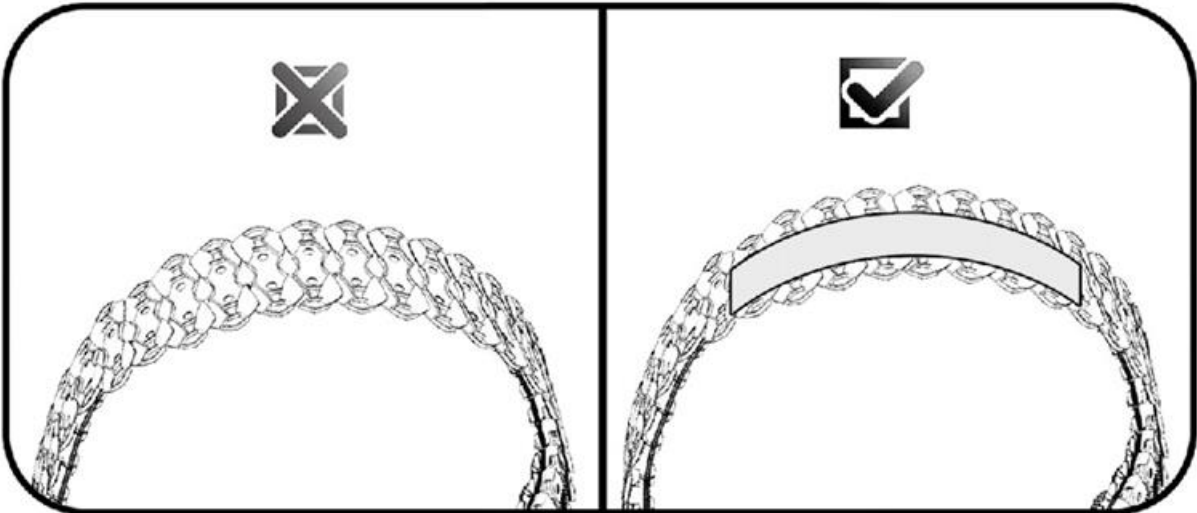
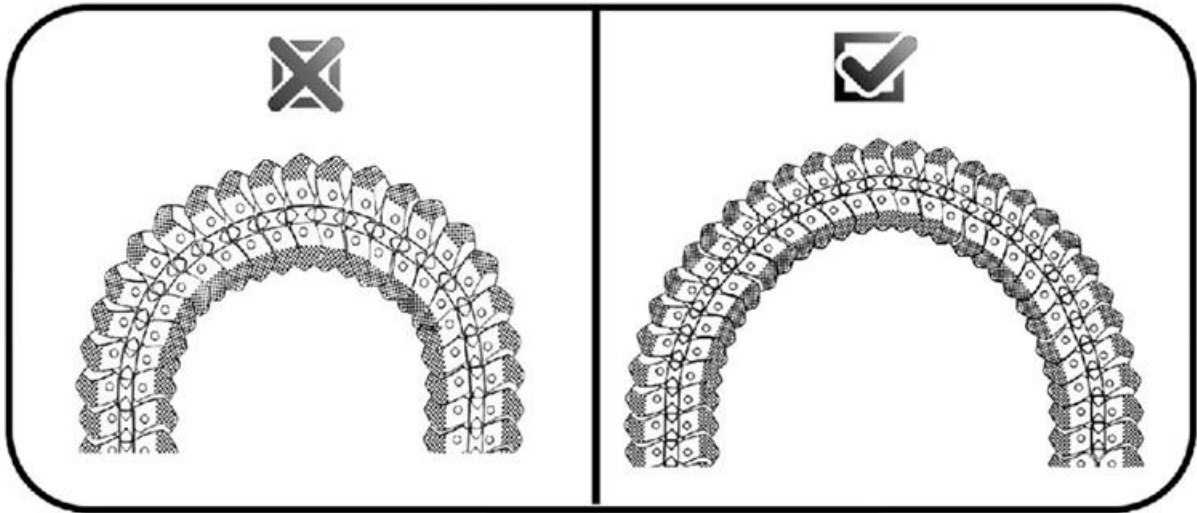



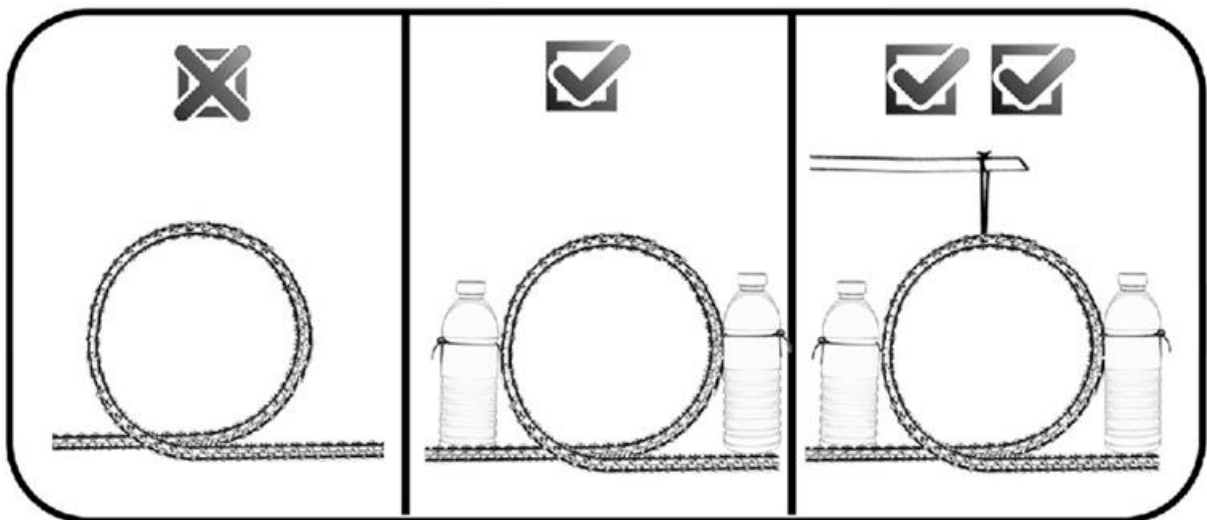
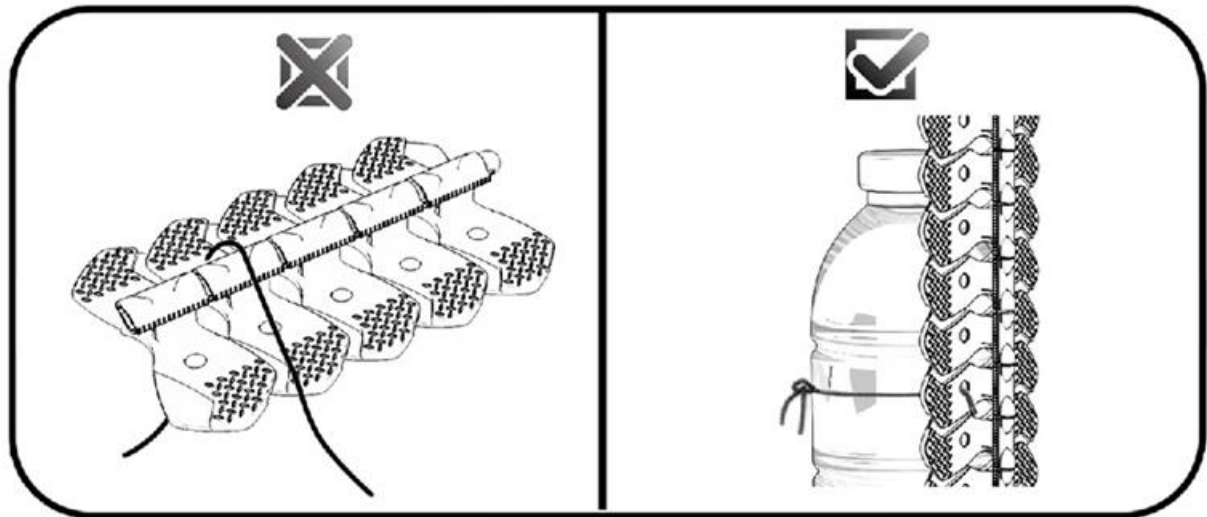
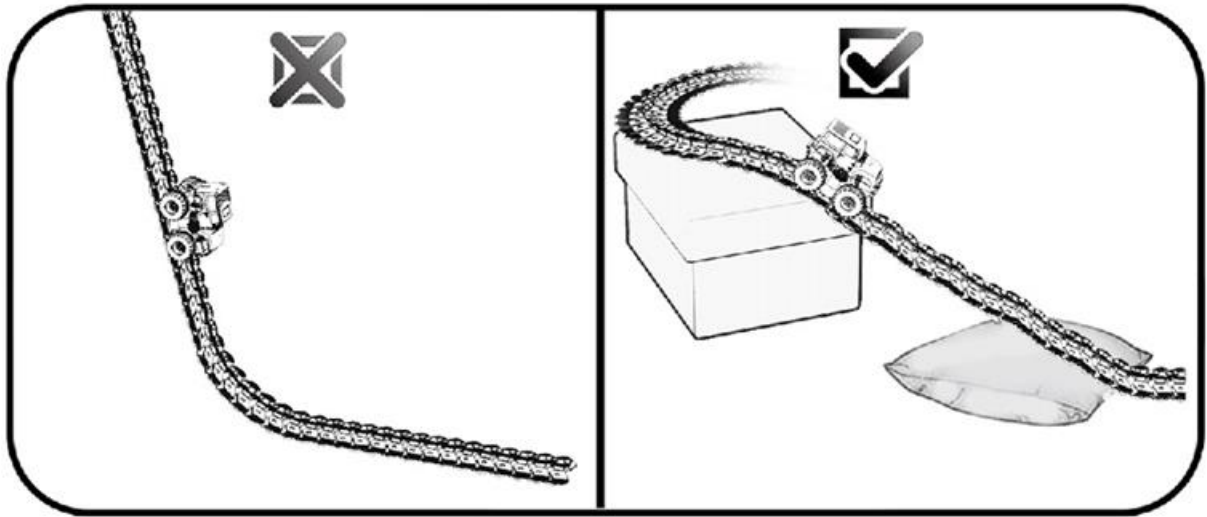

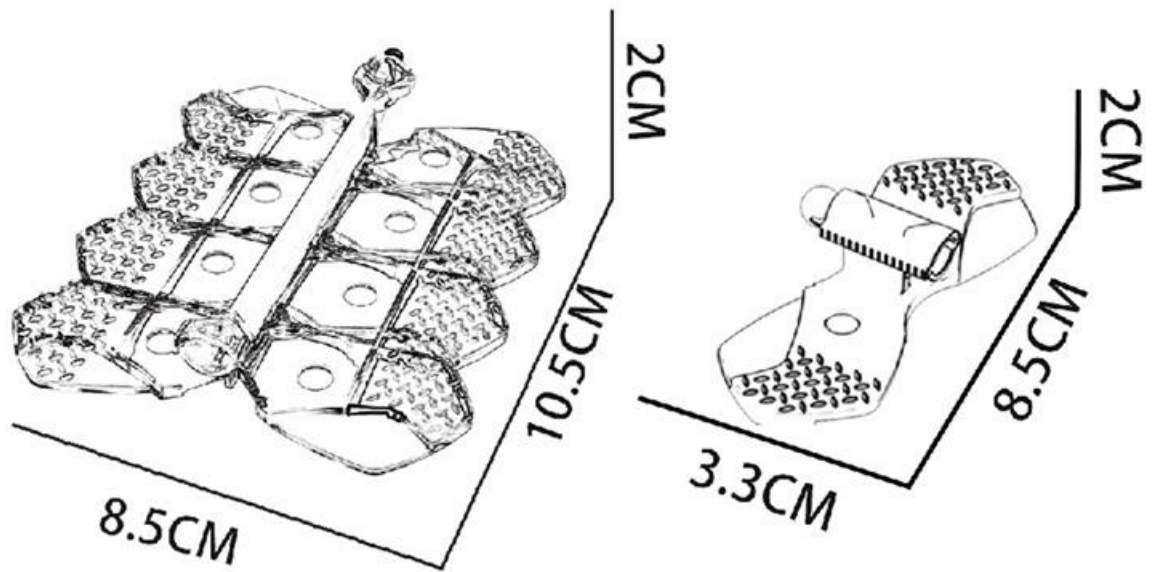

#### ANLEITUNGEN ZUR RECYCLING UND ENTSORGUNG:



Dieses Label bedeutet, dass das Produkt nicht wie üblicher Haushaltsmüll in der gesamten EU entsorgt werden darf. Um mögliche Schäden an der Umwelt oder der menschlichen Gesundheit durch unkontrollierte Abfallentsorgung zu verhindern. Recyceln Sie verantwortungsbewusst, um die nachhaltige Nutzung von Materialressourcen zu fördern. Wenn Sie ein gebrauchtes Gerät zurückgeben möchten, verwenden Sie das Abgabesystem oder wenden Sie sich an den Händler, bei dem Sie das Produkt gekauft haben. Der Händler kann das Produkt umweltfreundlich recyceln.



Eine Erklärung des Herstellers, dass das Produkt den Anforderungen der geltenden EU-Richtlinien entspricht.

## CZ: LUMITRACK - UŽIVATELSKÁ PŘÍRUČKA

### NABÍJENÍ BATERIE

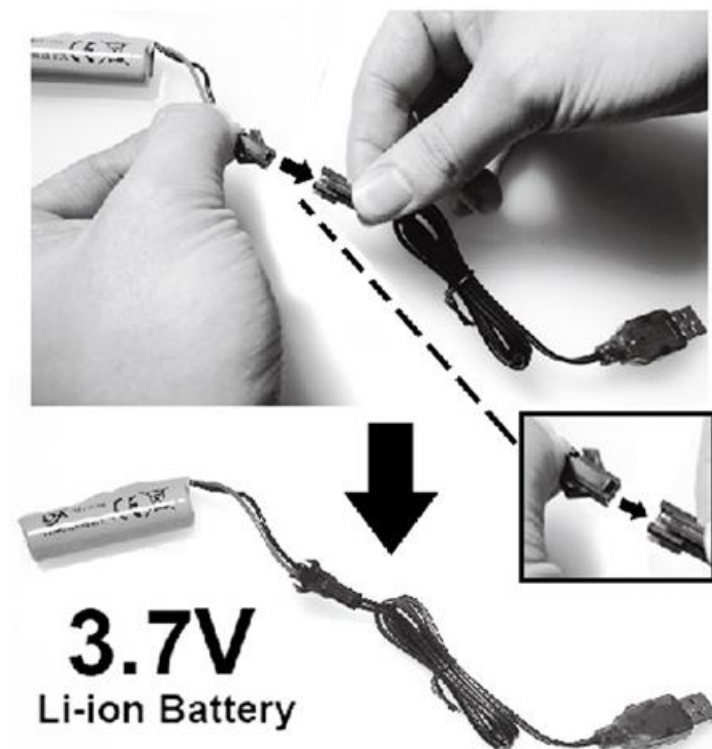

3,7V li-ion baterie a nabíječka jsou součástí balení výrobku.

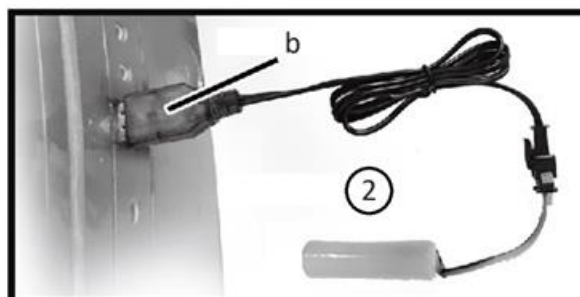
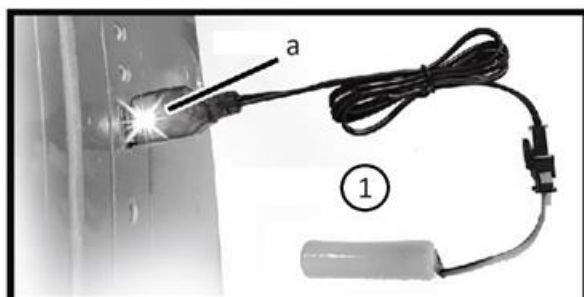

1. Nabíjení baterie

a) Jasná světla

2. Plně nabitá baterie

b) Žádná světla

Při plném nabití svítí výrobek 70-90 minut.

NÁVOD K MONTÁŽI VOZU

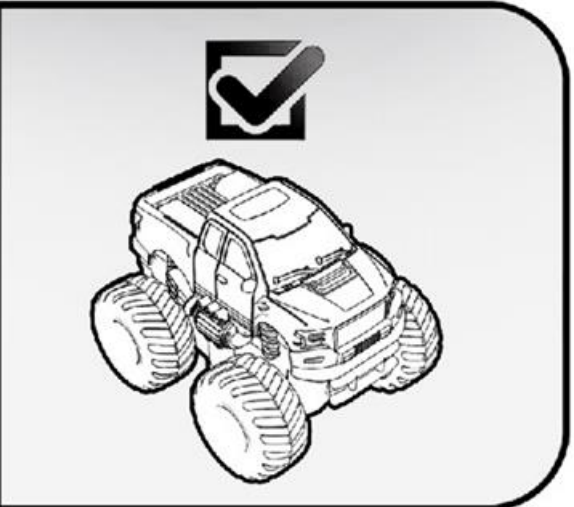
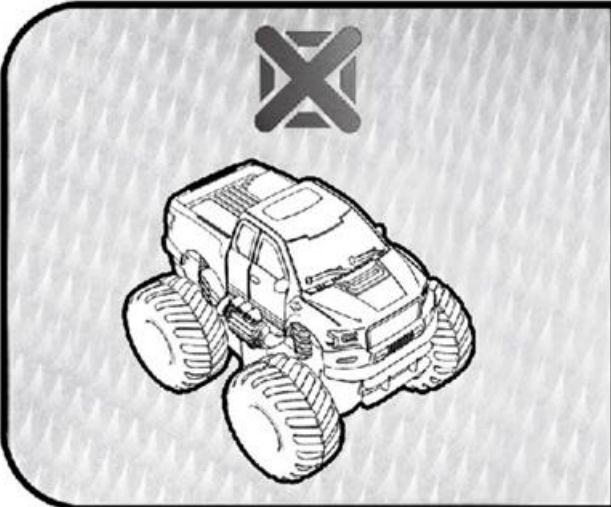
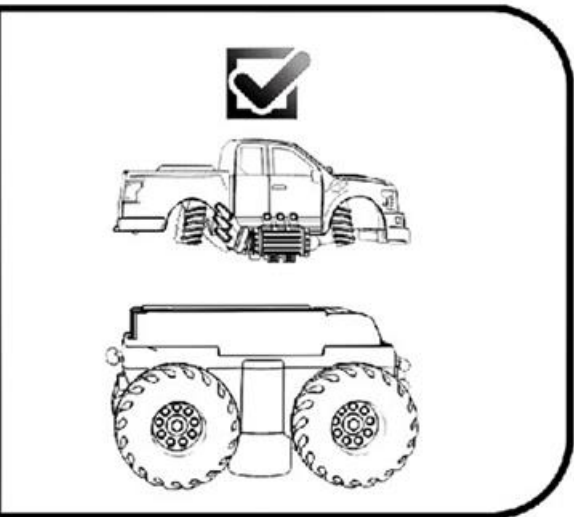
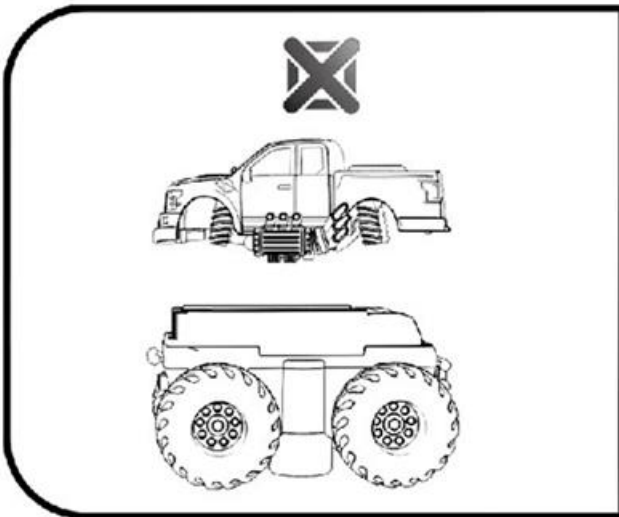
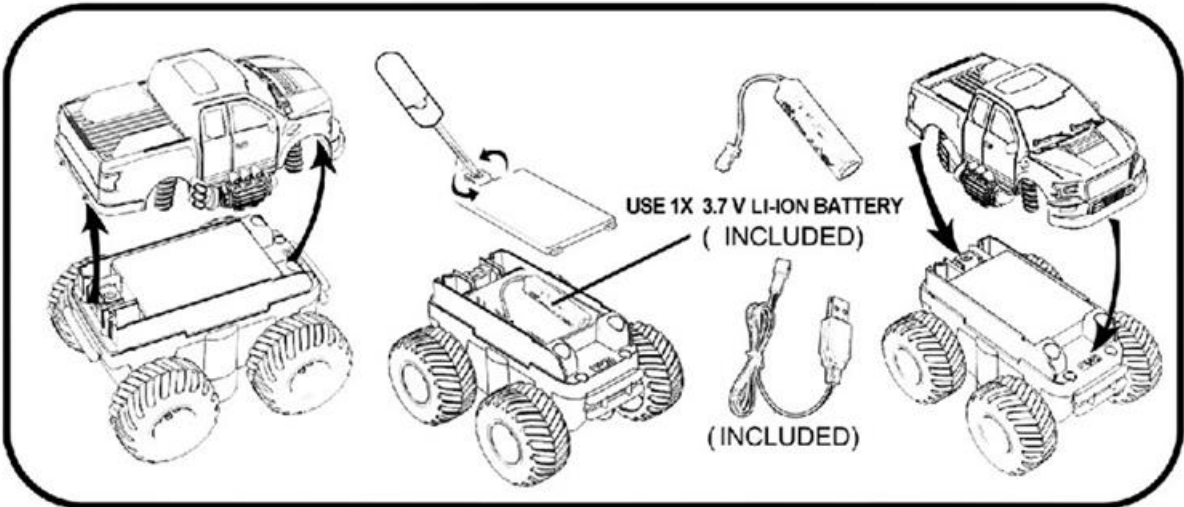



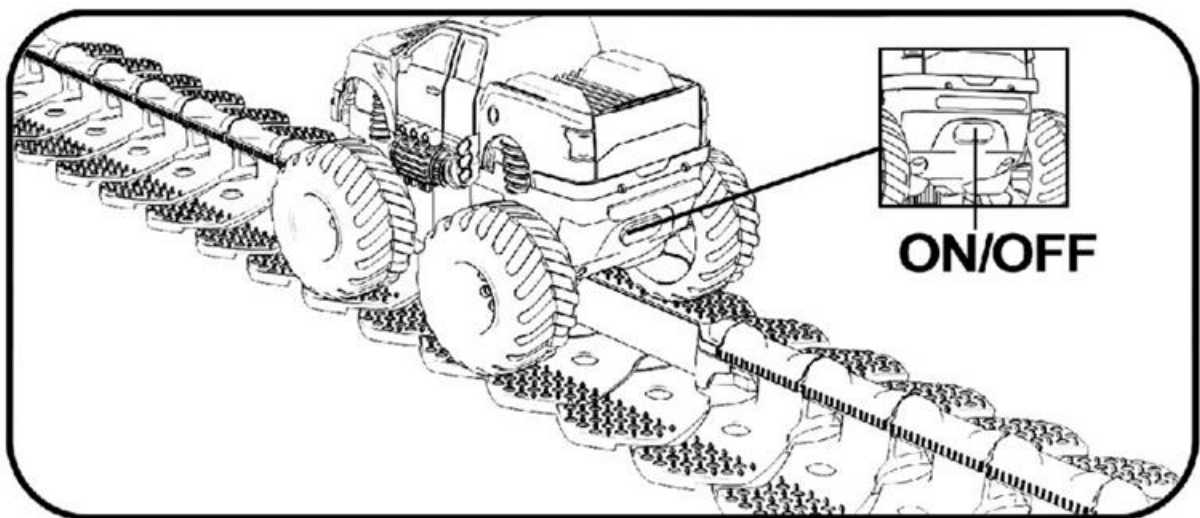
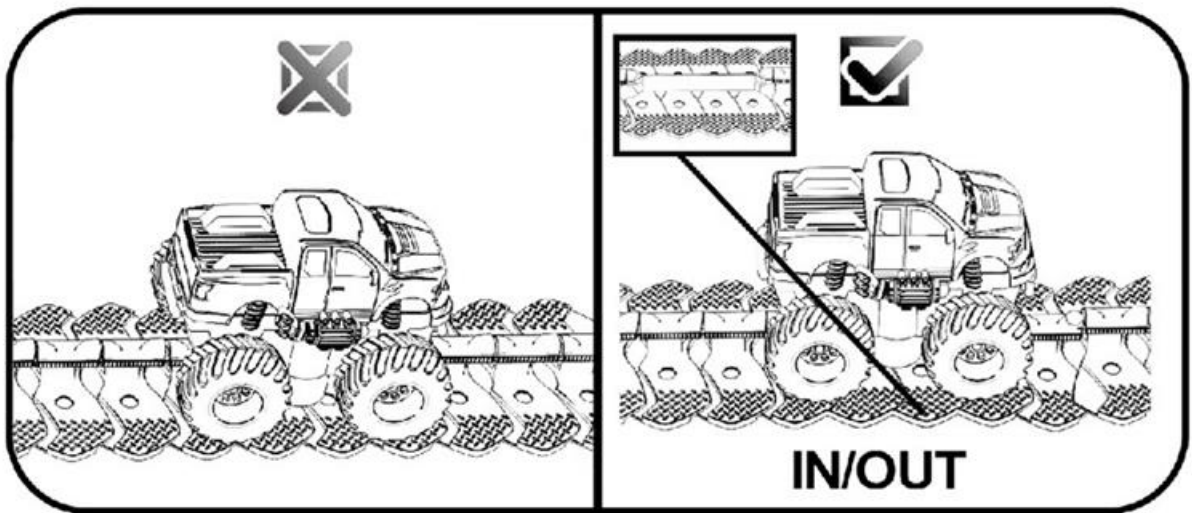

UMÍSTĚNÍ ŠTÍTKŮ: VŮZ 1





## UMÍSTĚNÍ ŠTÍTKŮ: VŮZ 2

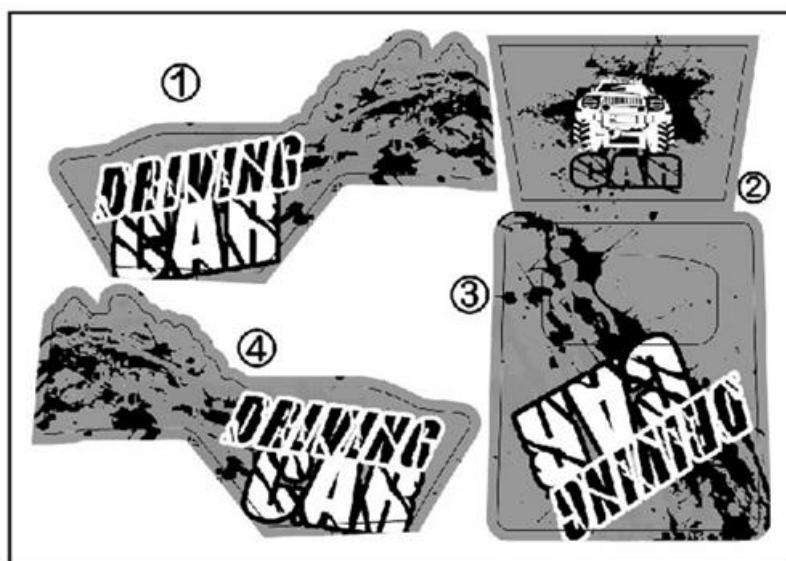





### SESTAVENÍ KOLEJÍ

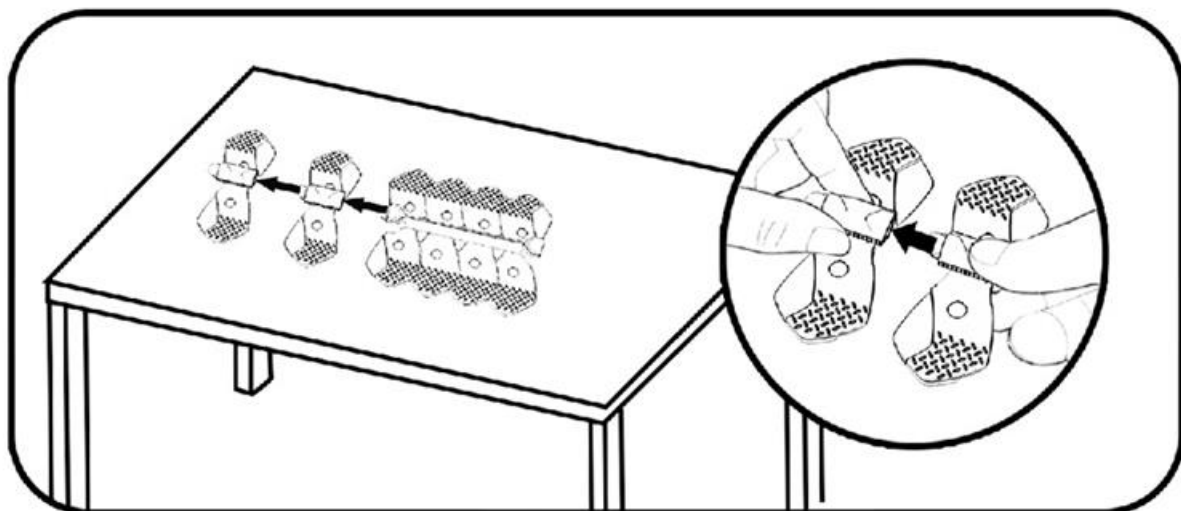



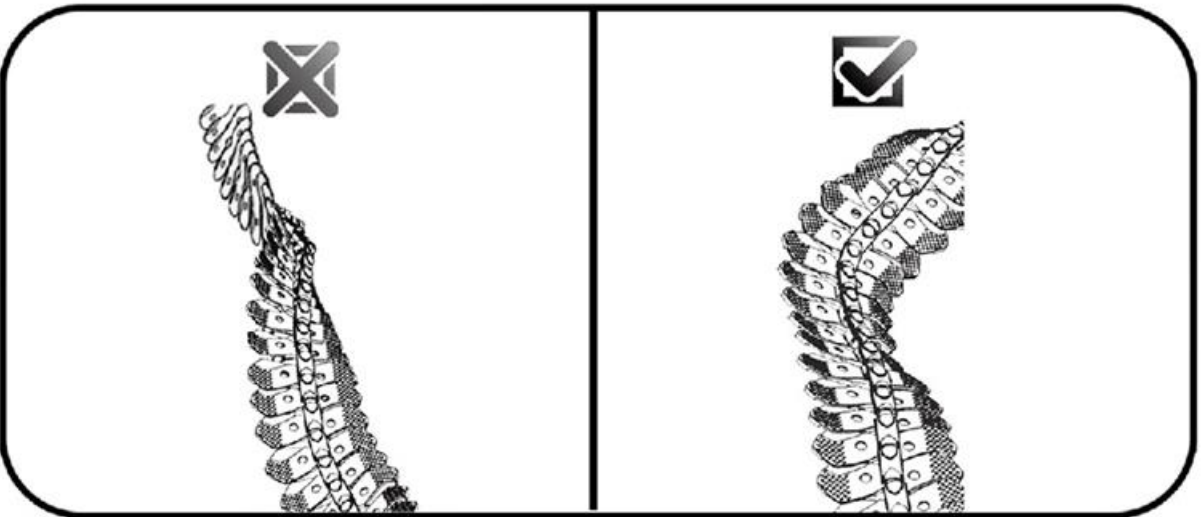
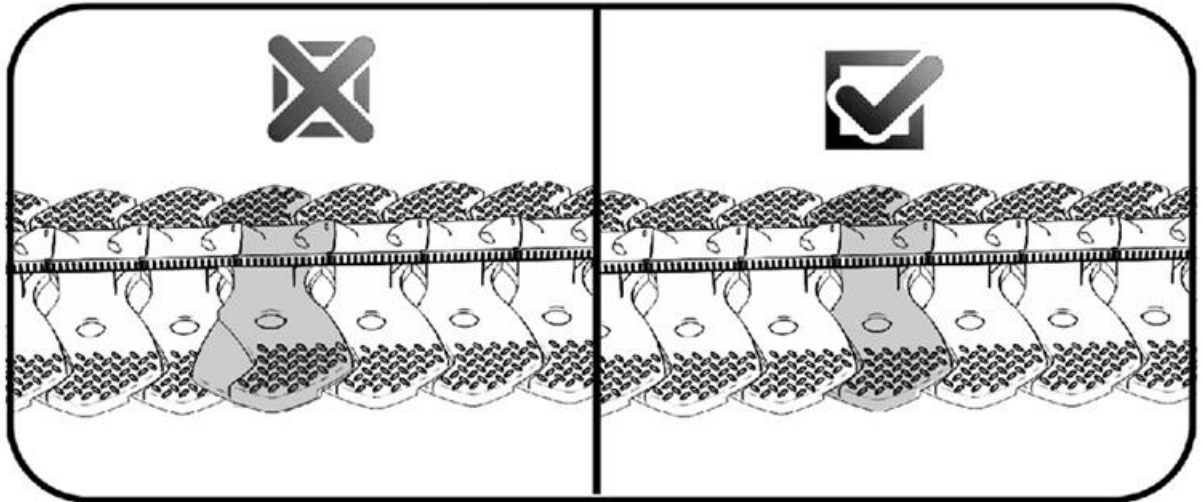
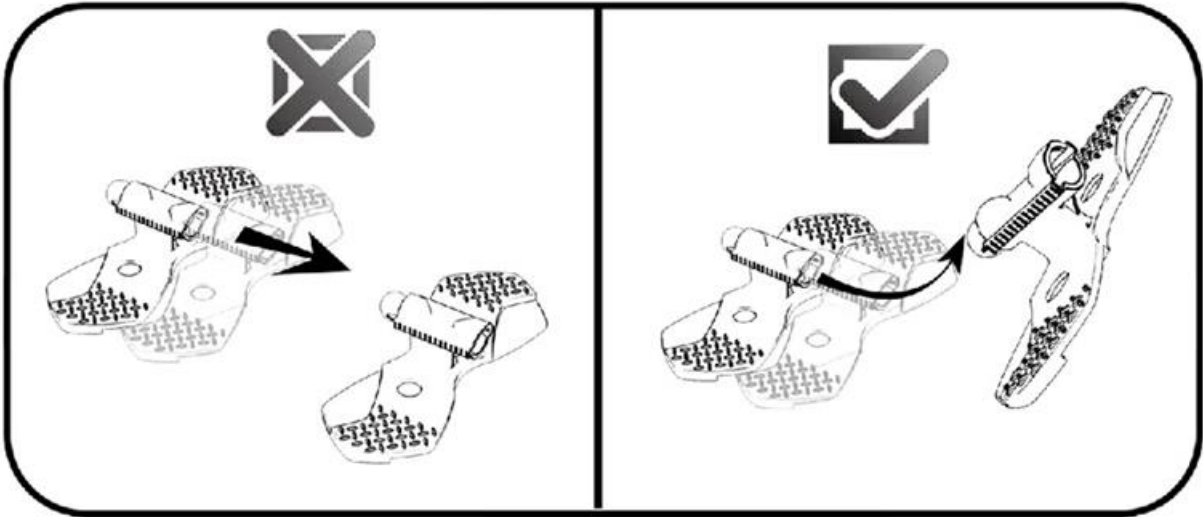

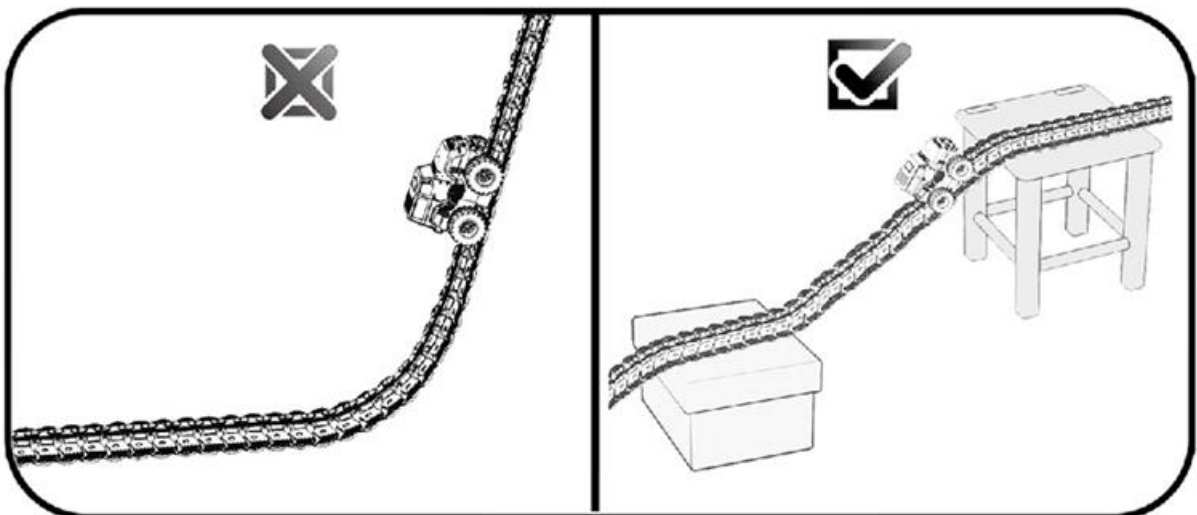
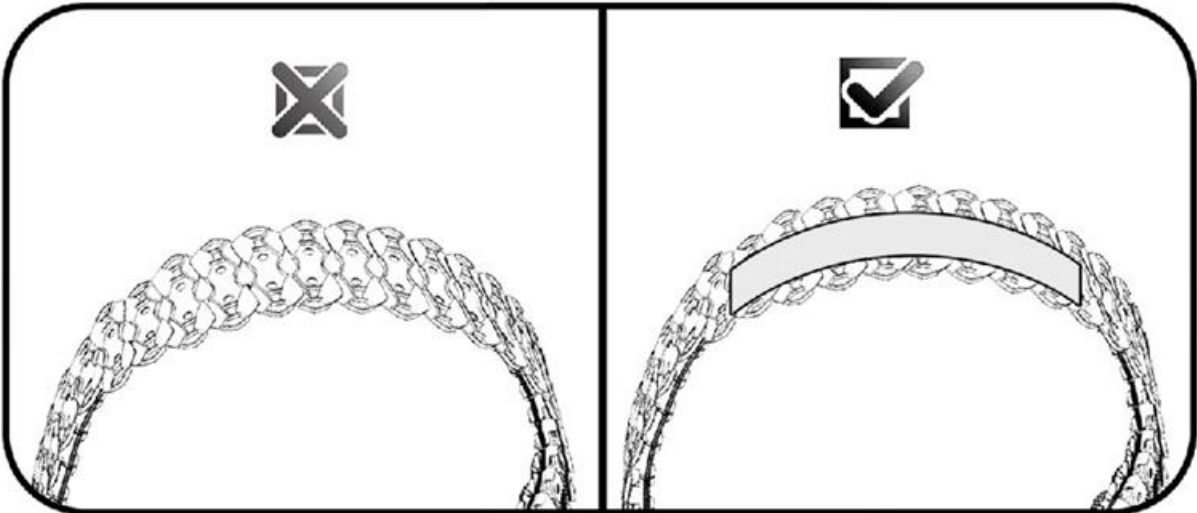
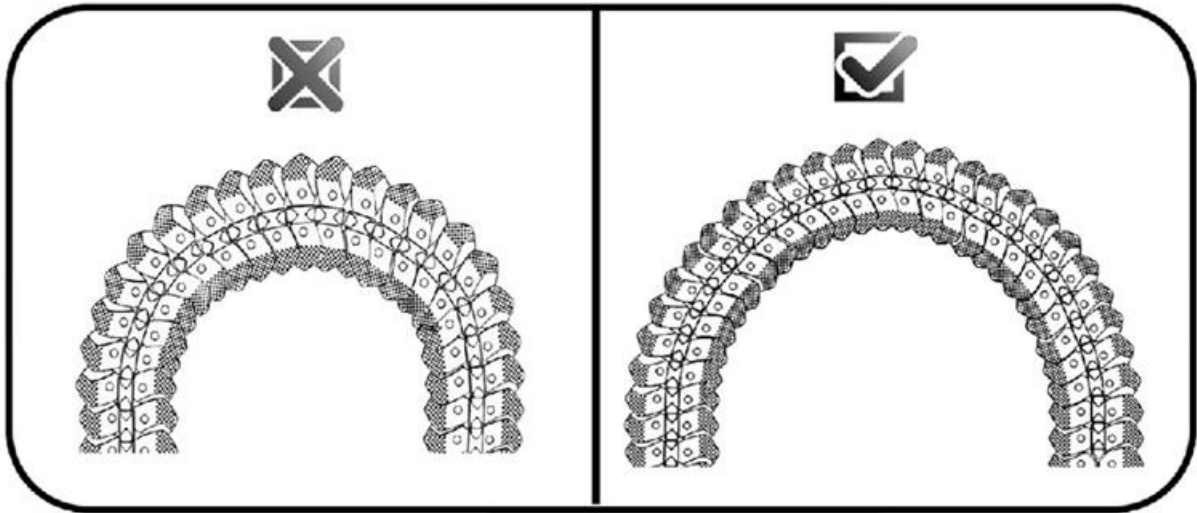

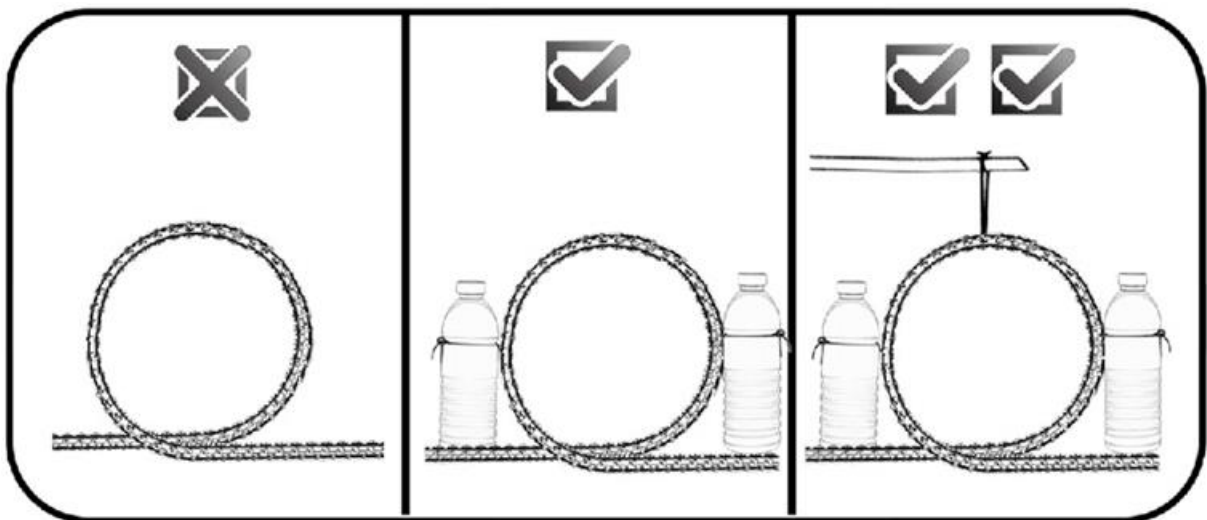
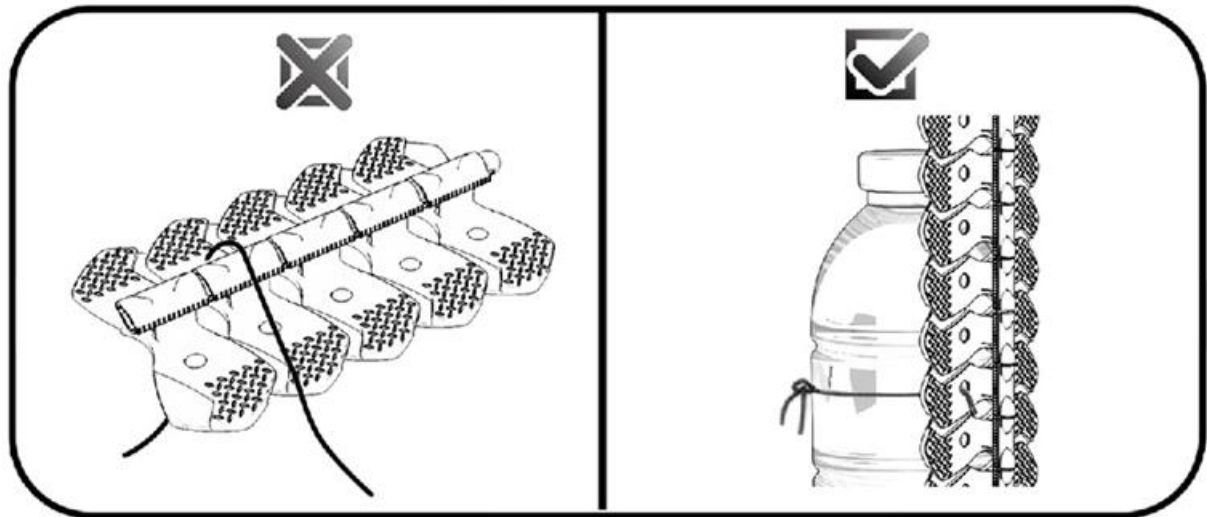
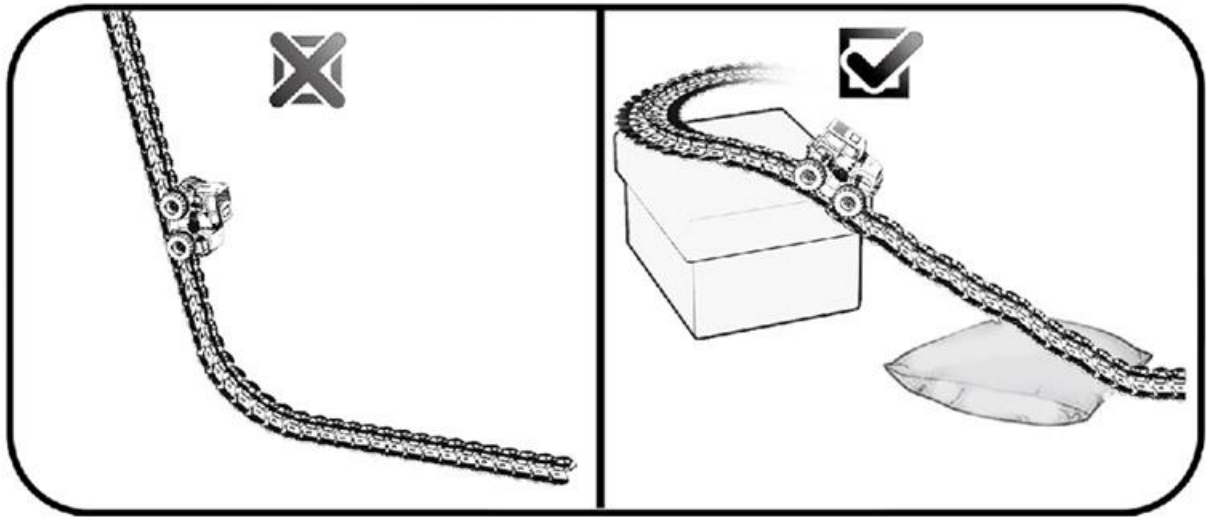

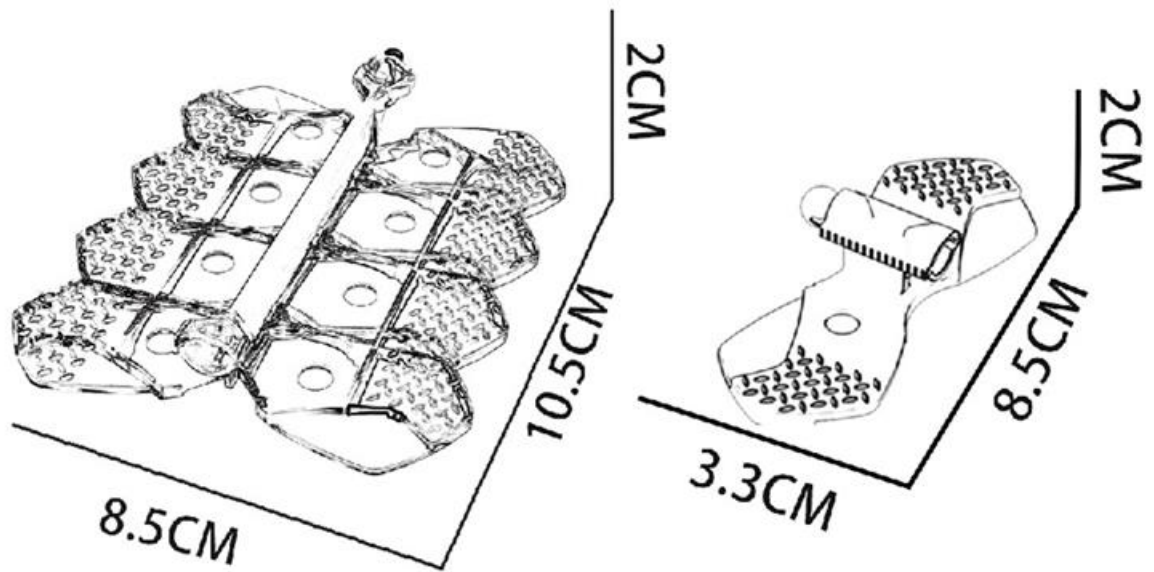

#### NÁVODY K RECYKLACI A ODSTRANĚNÍ:



Toto označení znamená, že výrobek nesmí být vyhozen jako běžný domácí odpad po celé EU. Abyste předešli možným škodám na životním prostředí nebo lidskému zdraví z nekontrolované likvidace odpadu. Recyklujte odpovědně k podpoře udržitelného využívání materiálních zdrojů. Chcete-li vrátit použitý zařízení, použijte systém odběru a sběru, nebo kontaktujte prodejce, od kterého jste produkt zakoupili. Prodejce může přijmout výrobek k ekologicky bezpečnému recyklování.



Prohlášení výrobce, že výrobek splňuje požadavky příslušných směrnic EU.



## PL: LUMITRACK - INSTRUKCJA OBSŁUGI

### ŁADOWANIE AKUMULATORA

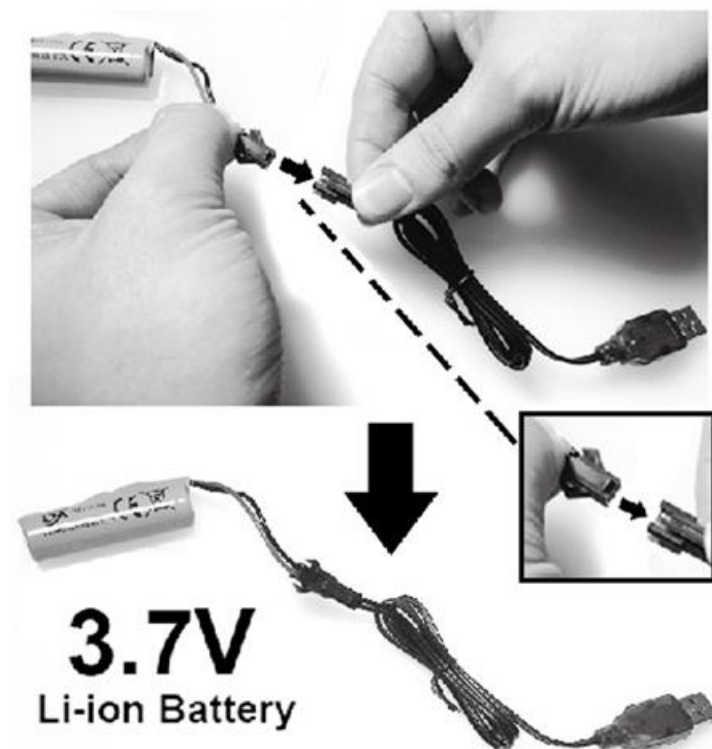

Akumulator litowo-jonowy 3,7 V i ładowarka znajdują się w opakowaniu produktu.

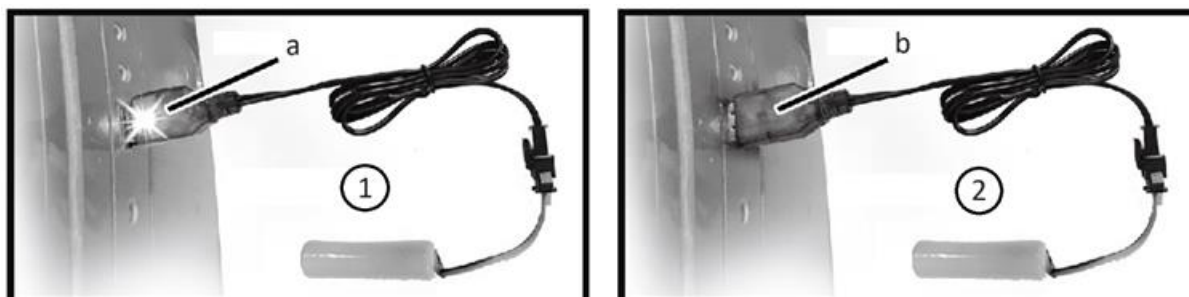

1. Ładowanie akumulatora

a) Jasne światło

2. Bateria w pełni naładowana

b) Brak światła

Po pełnym naładowaniu produkt świeci przez 70-90 minut.

INSTRUKCJA MONTAŻU W SAMOCHODZIE

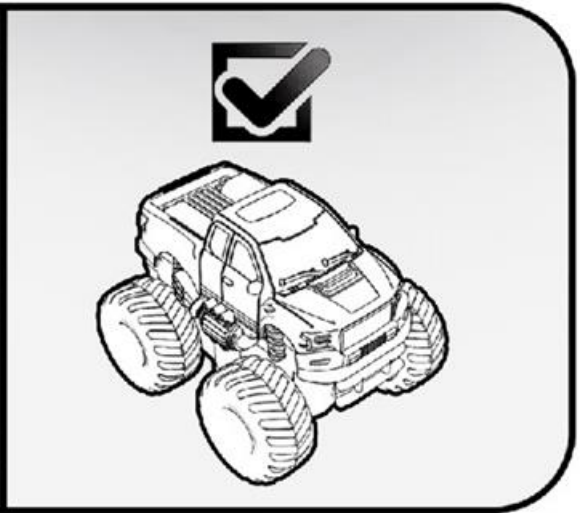
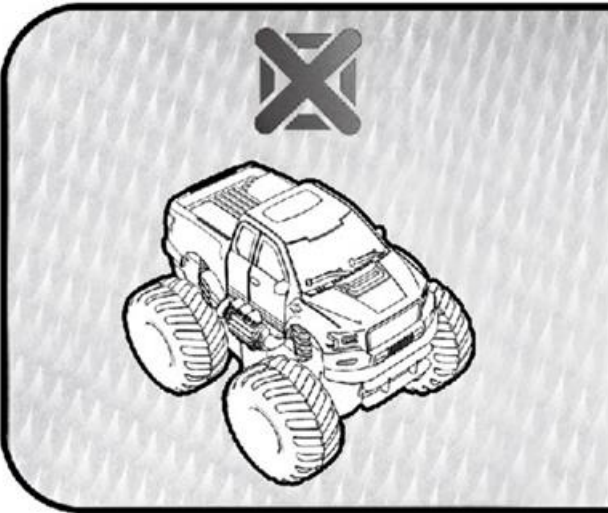
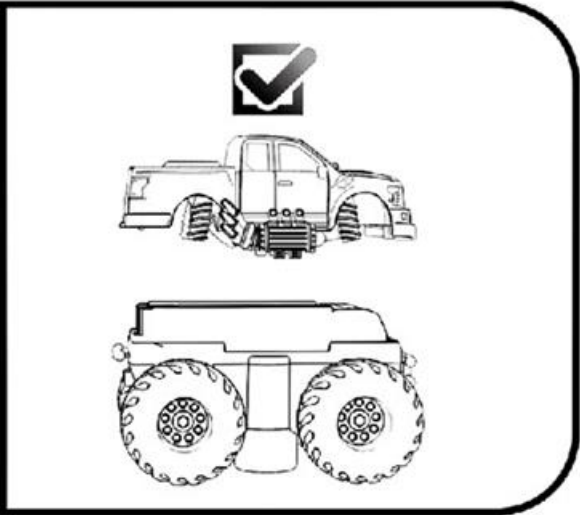
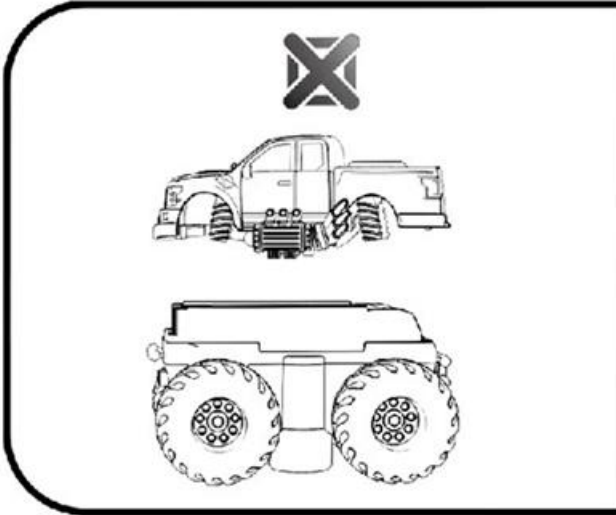
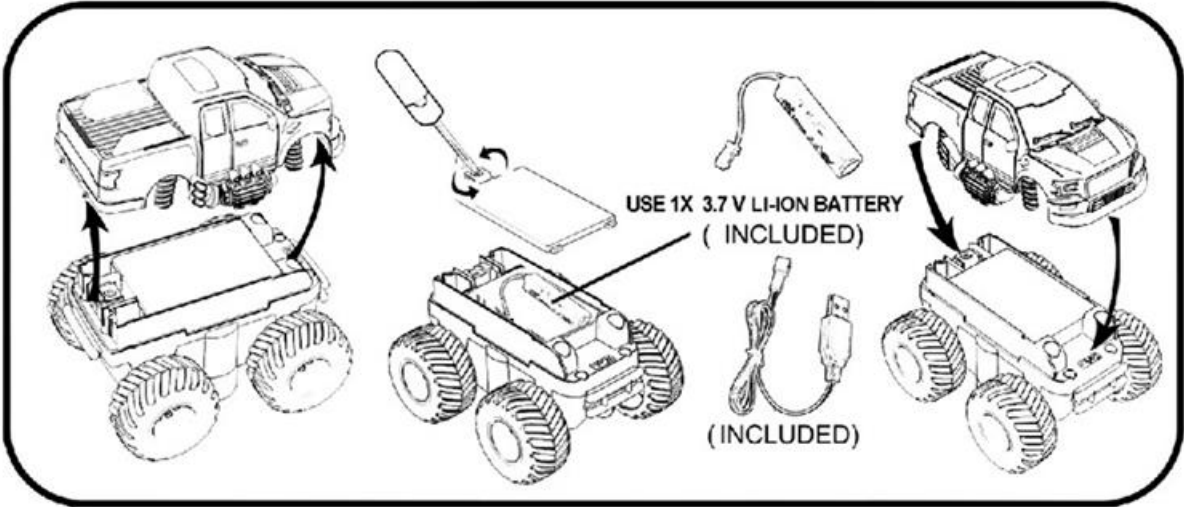

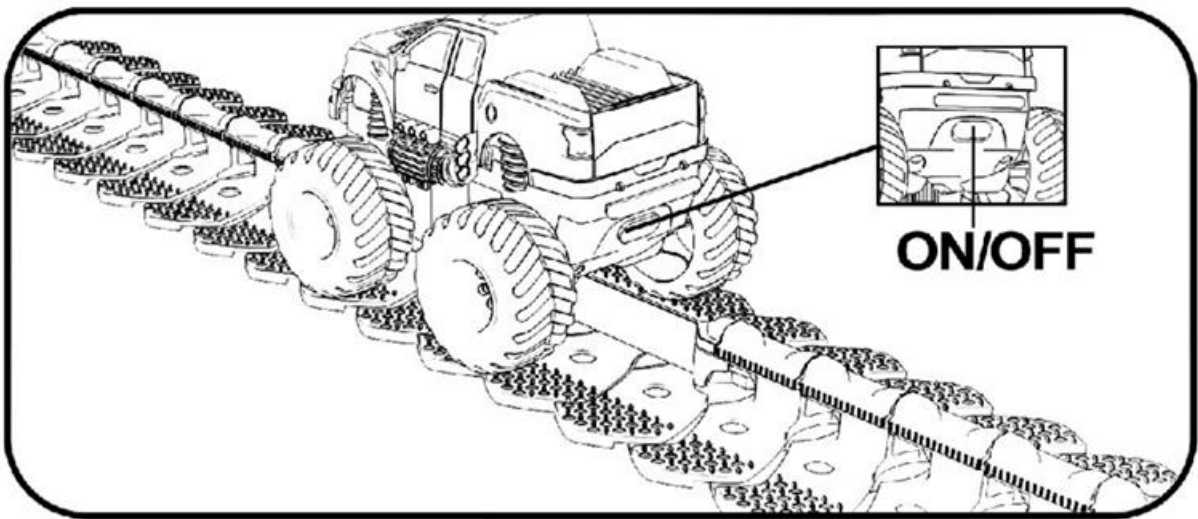
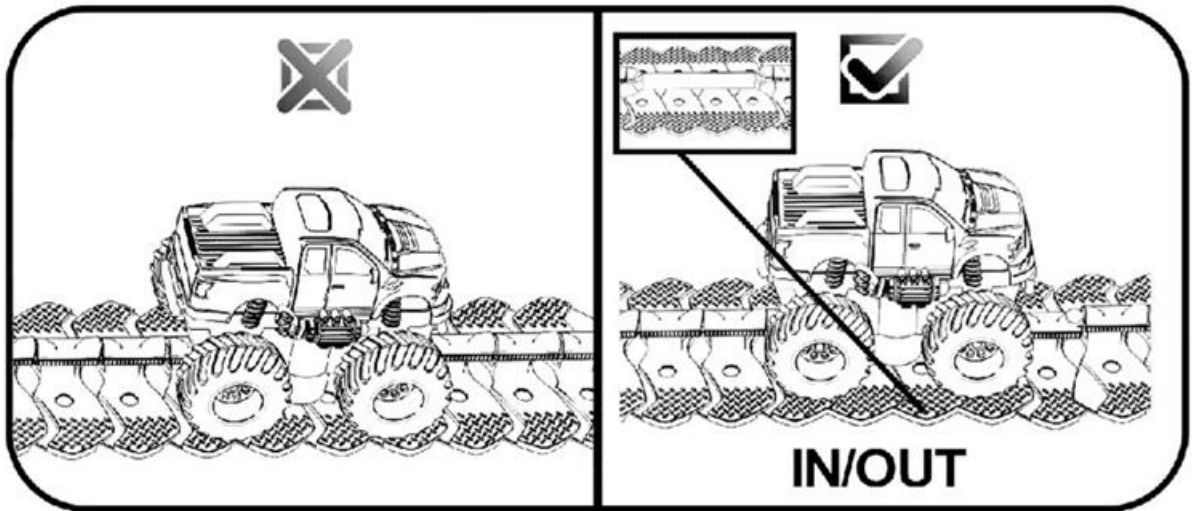

ROZMIESZCZENIE ETYKIET: SAMOCHÓD 1









ROZMIESZCZENIE ETYKIET: SAMOCHÓD 2

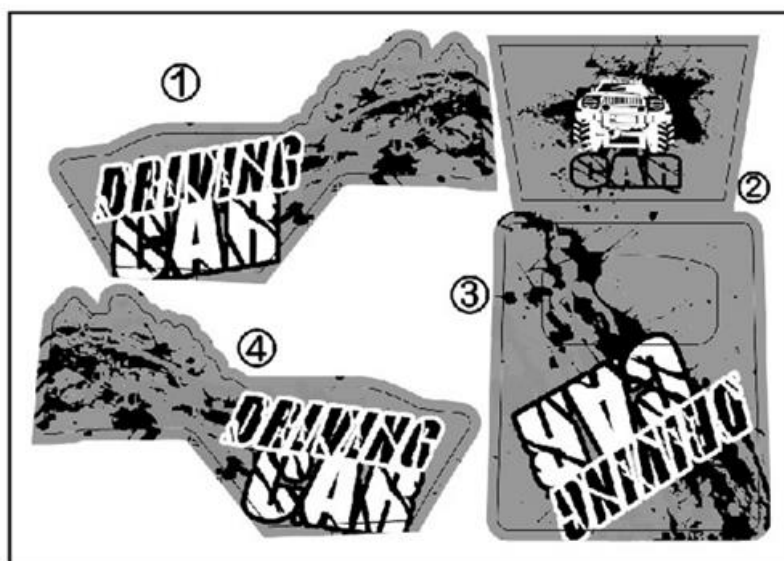



### MONTAŻ ŚCIEŻEK

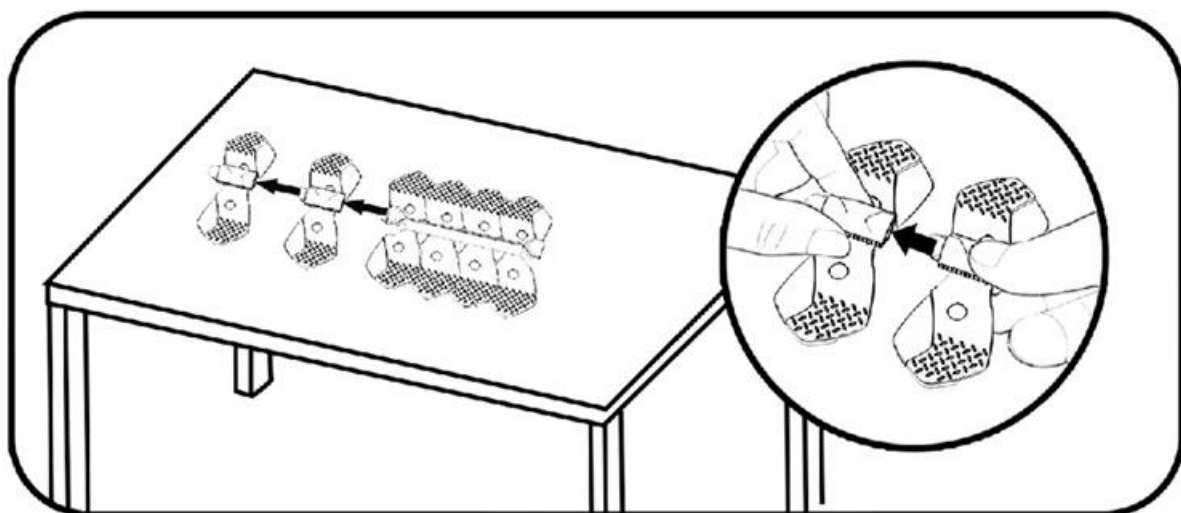

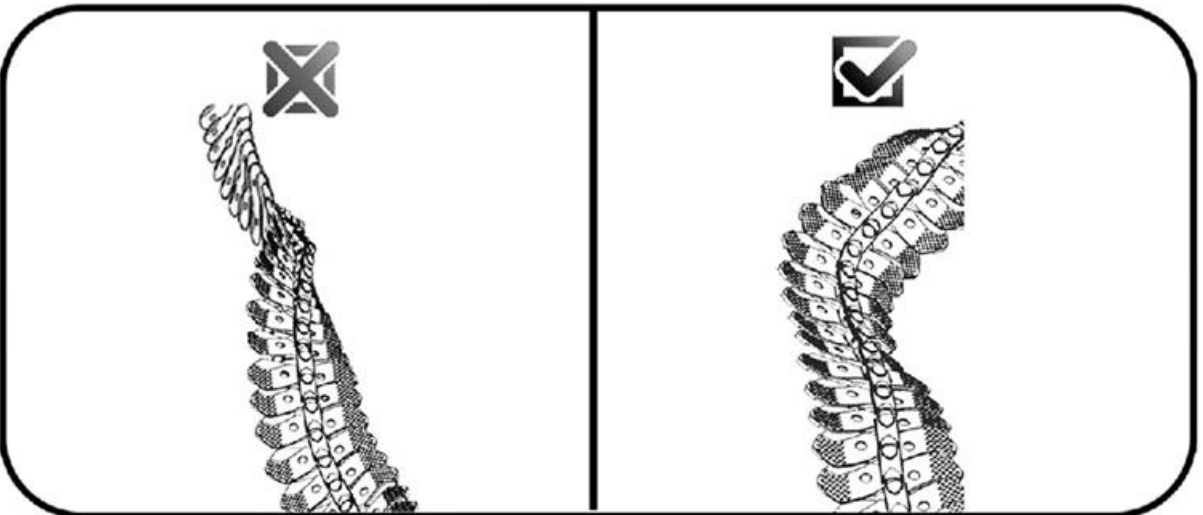
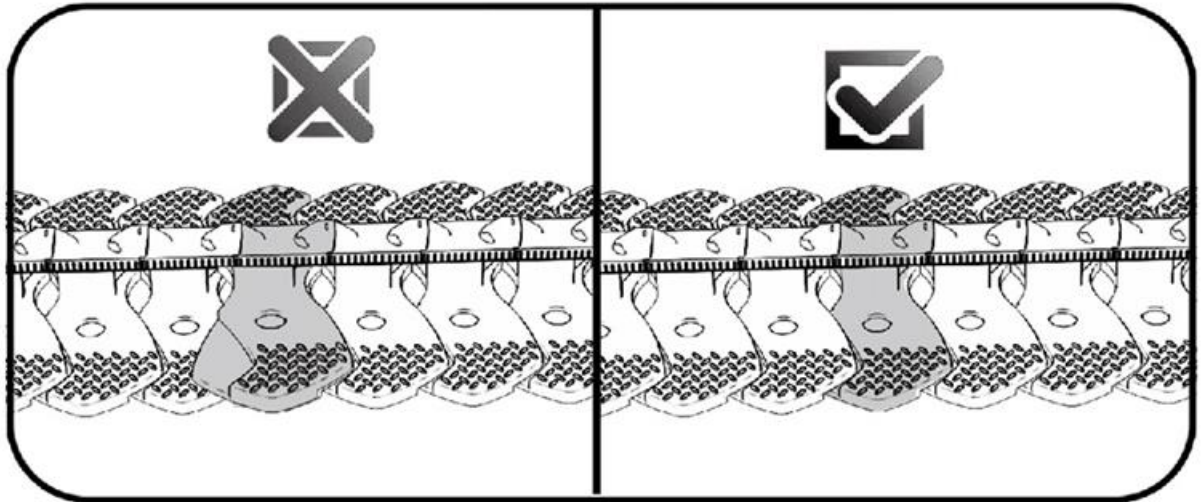
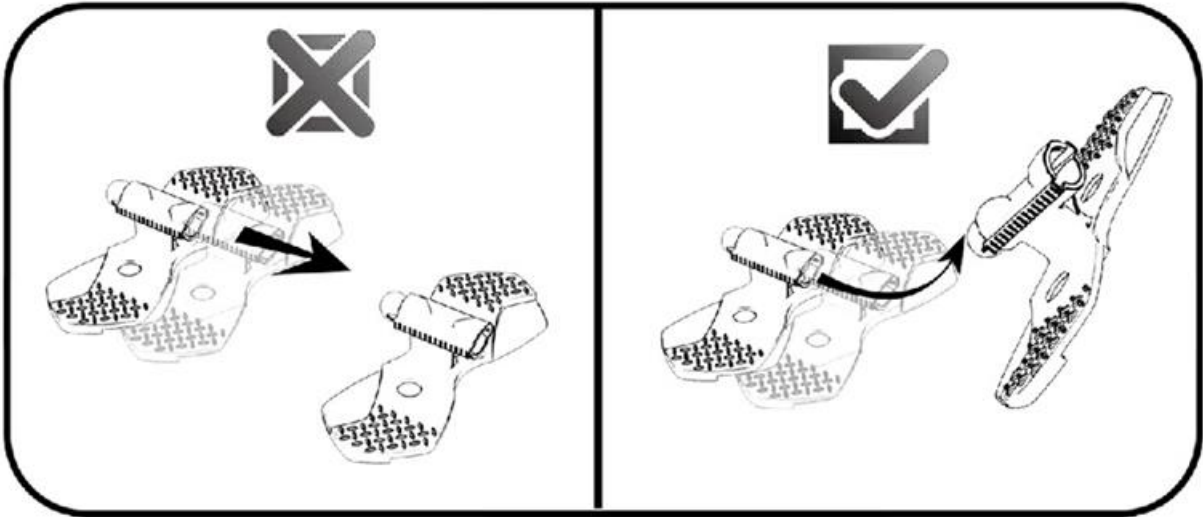

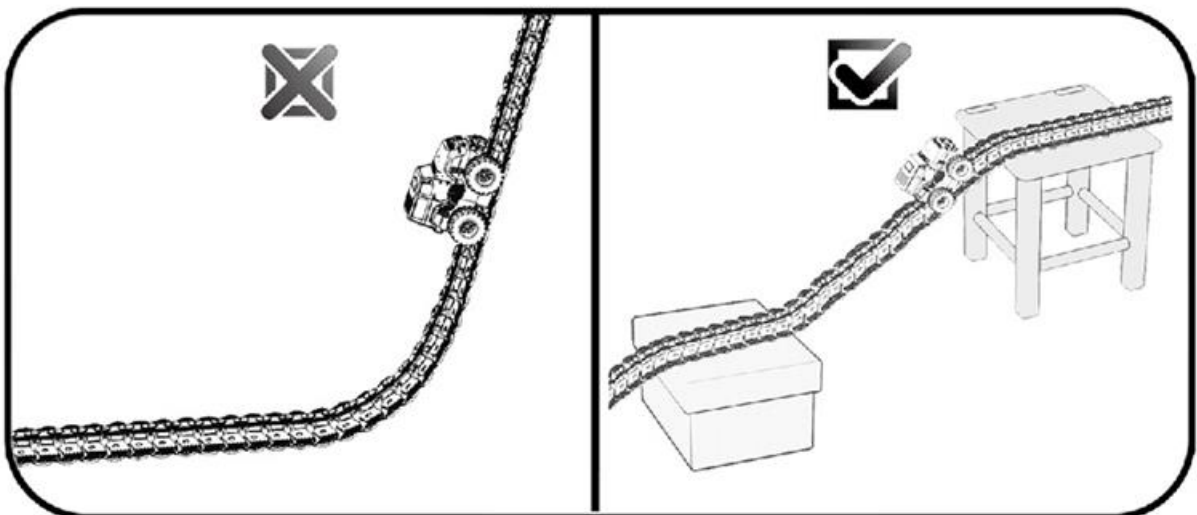
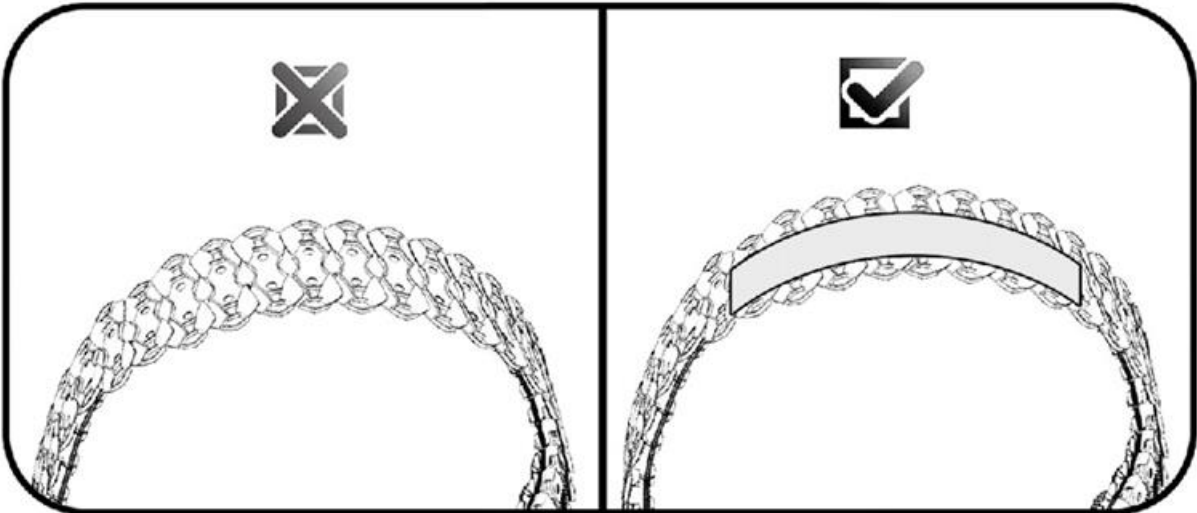
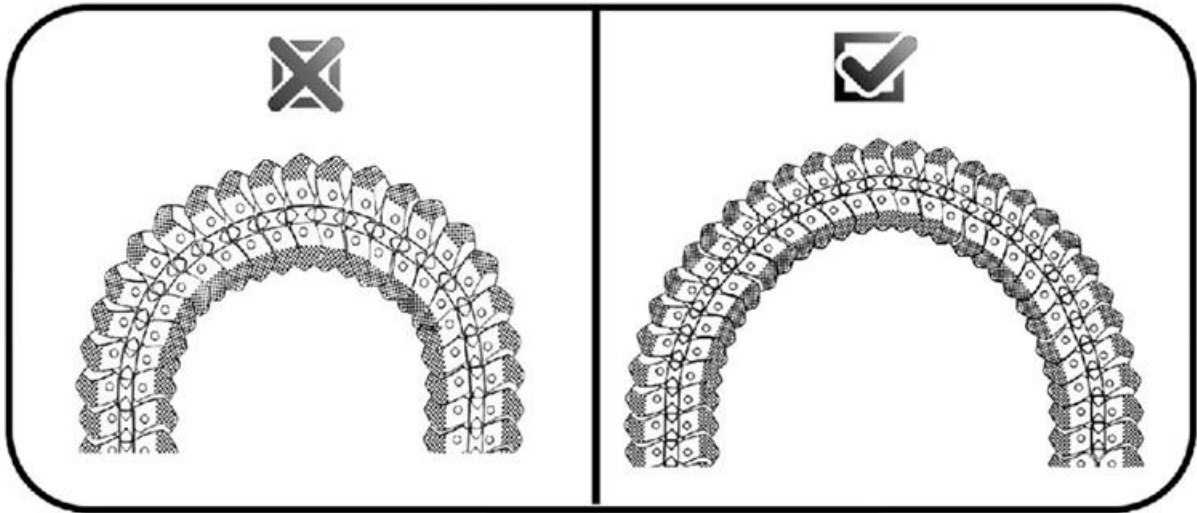



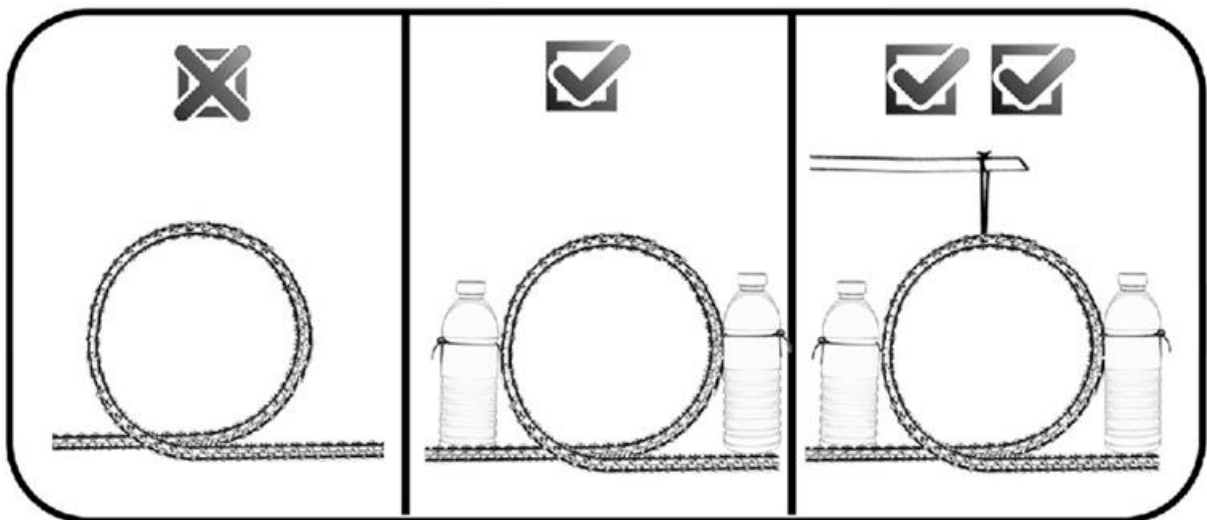
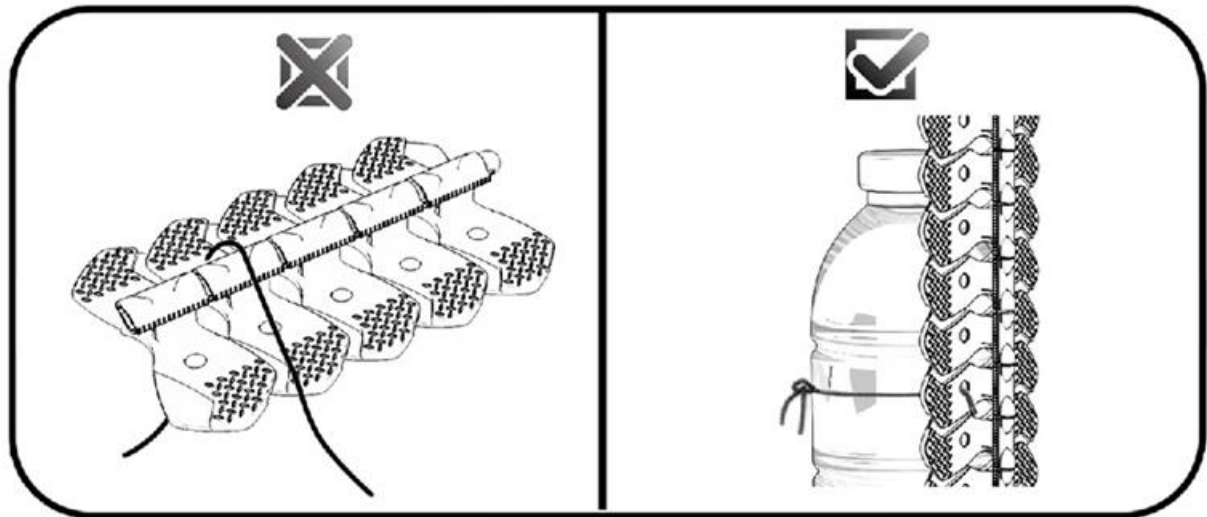
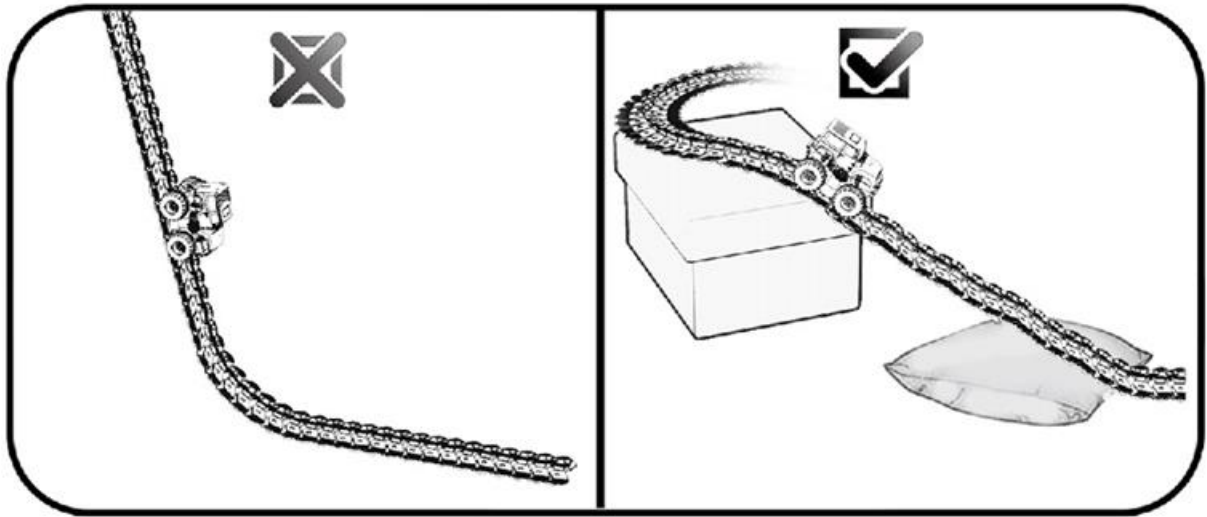

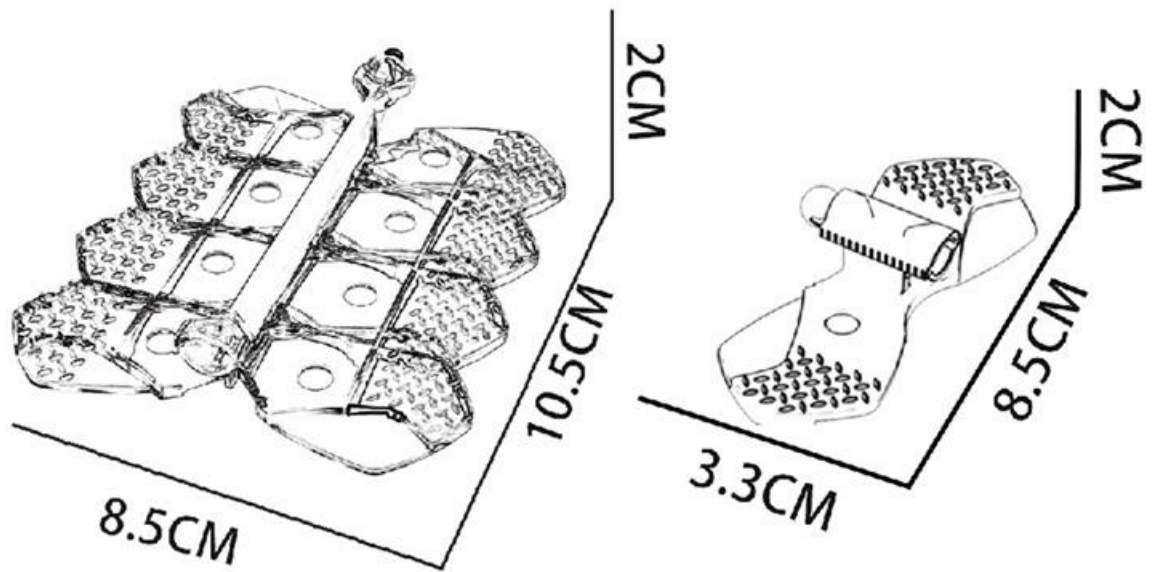

#### INSTRUKCJE DOTYCZĄCE RECYKLINGU I UTYLIZACJI:



Ta etykieta oznacza, że produkt nie może być usuwany jako zwykły odpad domowy w całej UE. Aby zapobiec potencjalnym szkodom dla środowiska lub zdrowia ludzkiego wynikającym z niekontrolowanego usuwania odpadów. Recykling prowadź odpowiedzialnie, aby promować zrównoważone korzystanie z zasobów materialnych. Jeśli chcesz zwrócić używane urządzenie, skorzystaj z systemu odbioru i kolekcji lub skontaktuj się z detalistą, od którego zakupiłeś produkt. Detalista może przyjąć produkt do ekologicznego recyklingu.



Oświadczenie producenta, że produkt spełnia wymagania odpowiednich dyrektyw UE.

## HU: LUMITRACK - FELHASZNÁLÓI KÉZIKÖNYV

### AZ AKKUMULÁTOR TÖLTÉSE

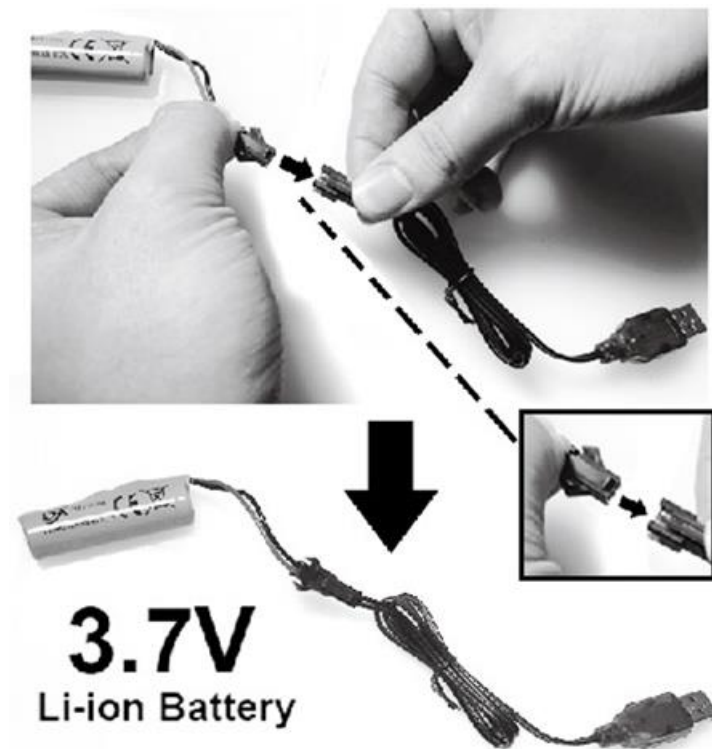

A 3,7 V-os Li-ion akkumulátort és töltőt a termék csomagolása tartalmazza.

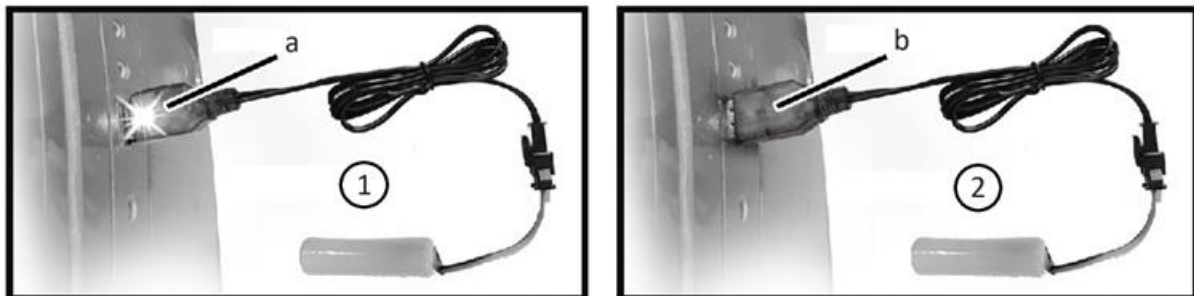

1. Az akkumulátor töltése

a) Világító fények

2. Teljesen feltöltött akkumulátor

b) Nincsenek fények

Teljesen feltöltve a termék 70-90 percig világít.

# AUTÓ ÖSSZESZERELÉSI ÚTMUTATÓ

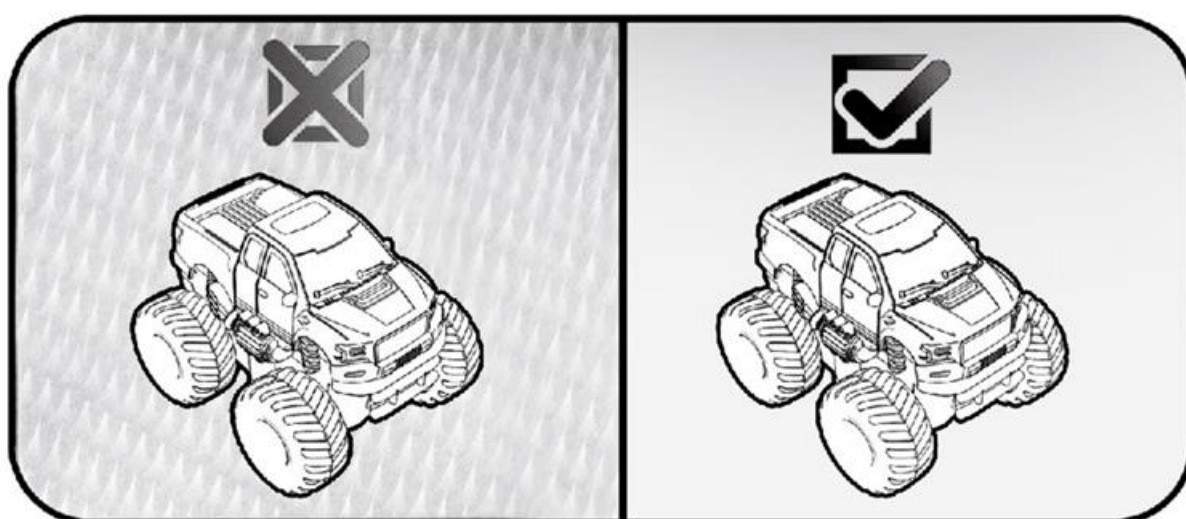
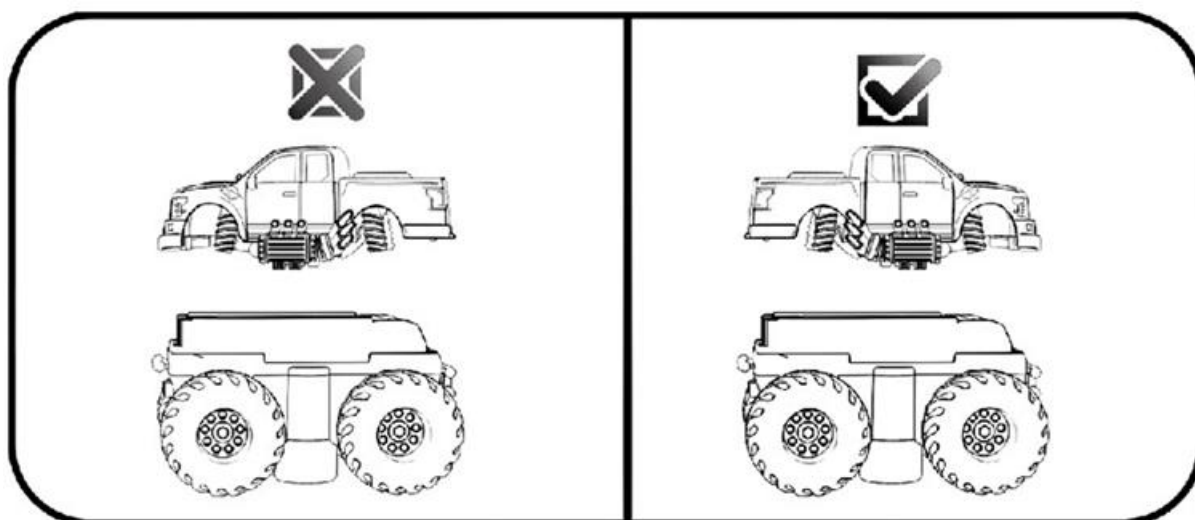
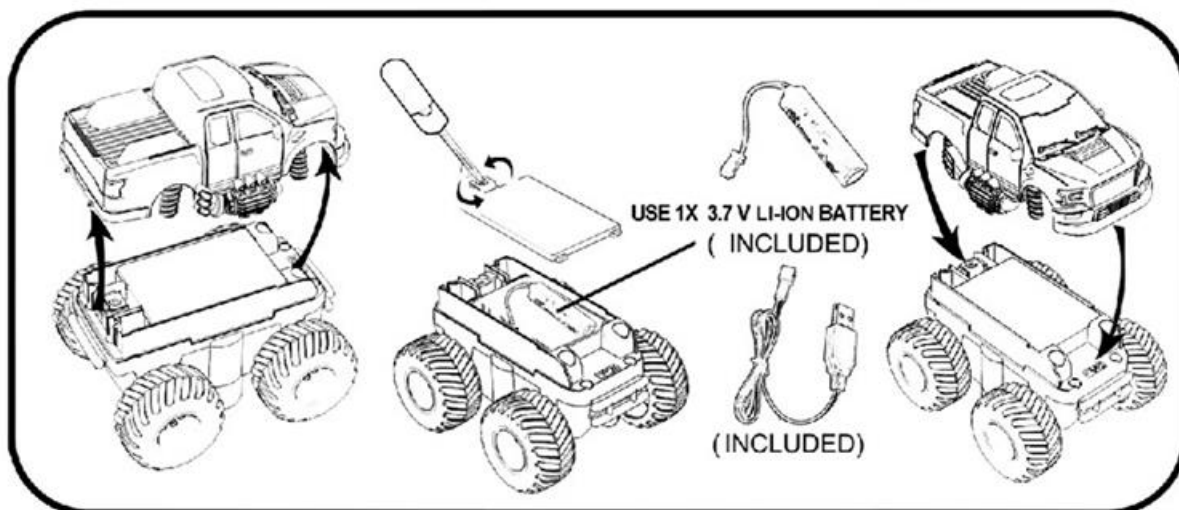



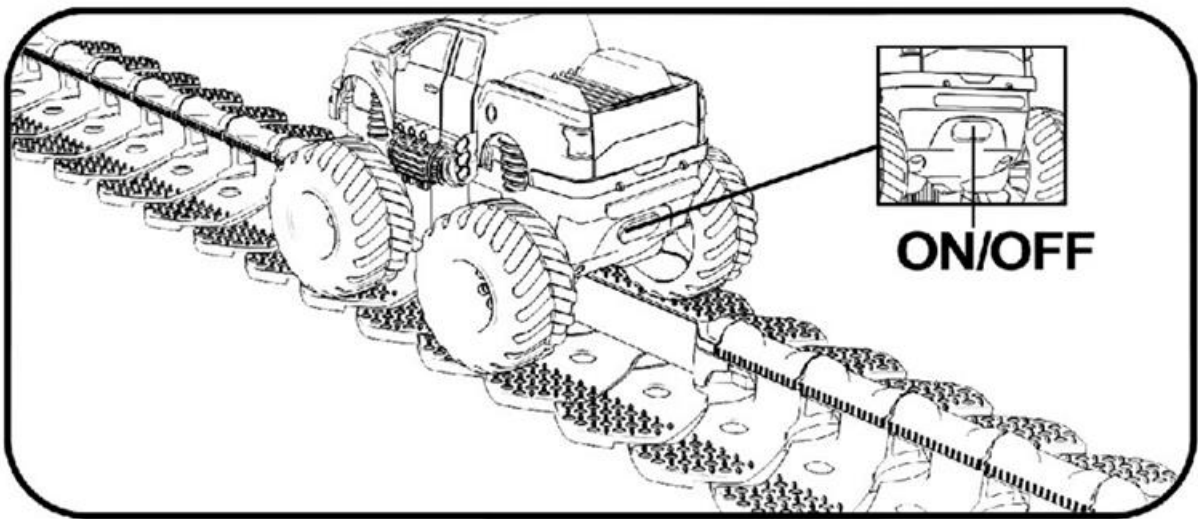
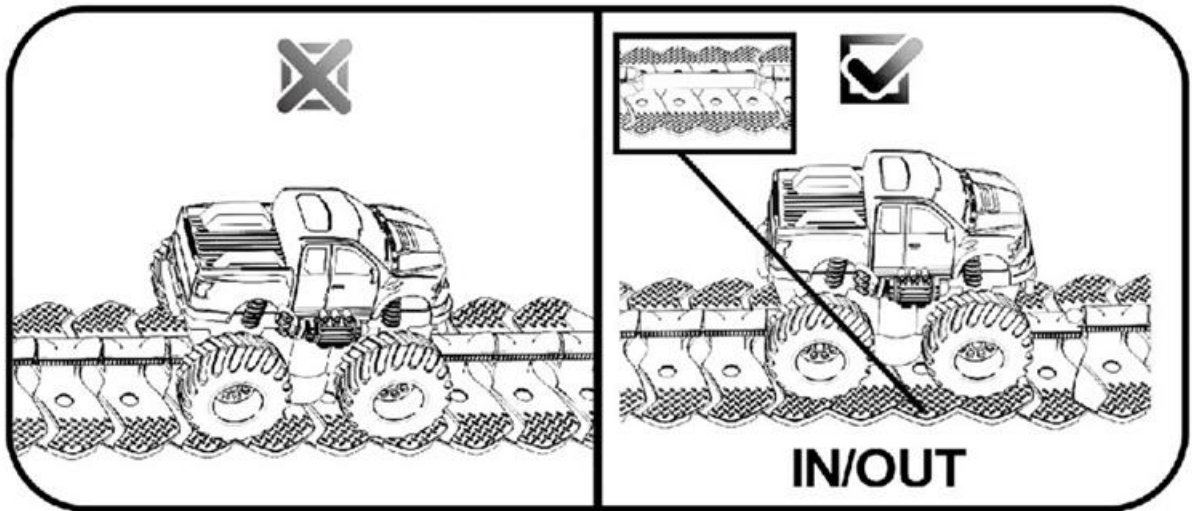

CÍMKÉK ELHELYEZÉSE: AUTÓ 1





CÍMKÉK ELHELYEZÉSE: CAR 2

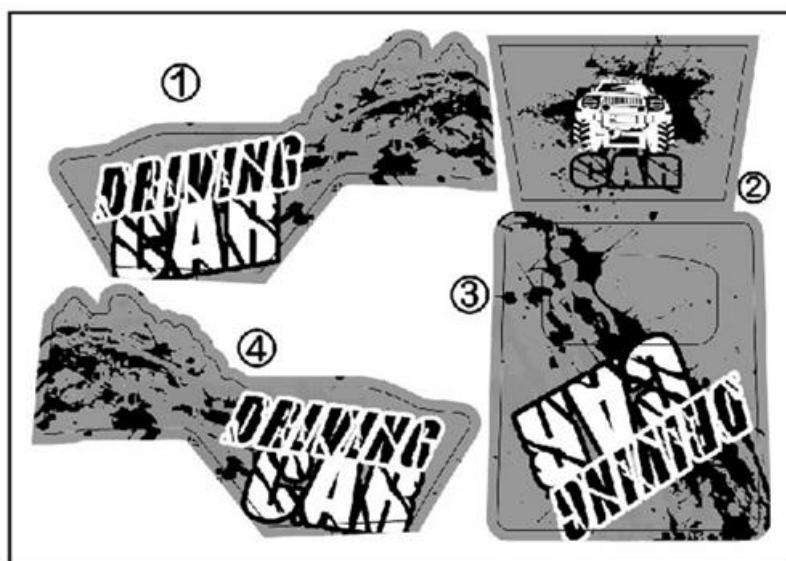





#### VÁGÁNYOK ÖSSZESZERELÉSE

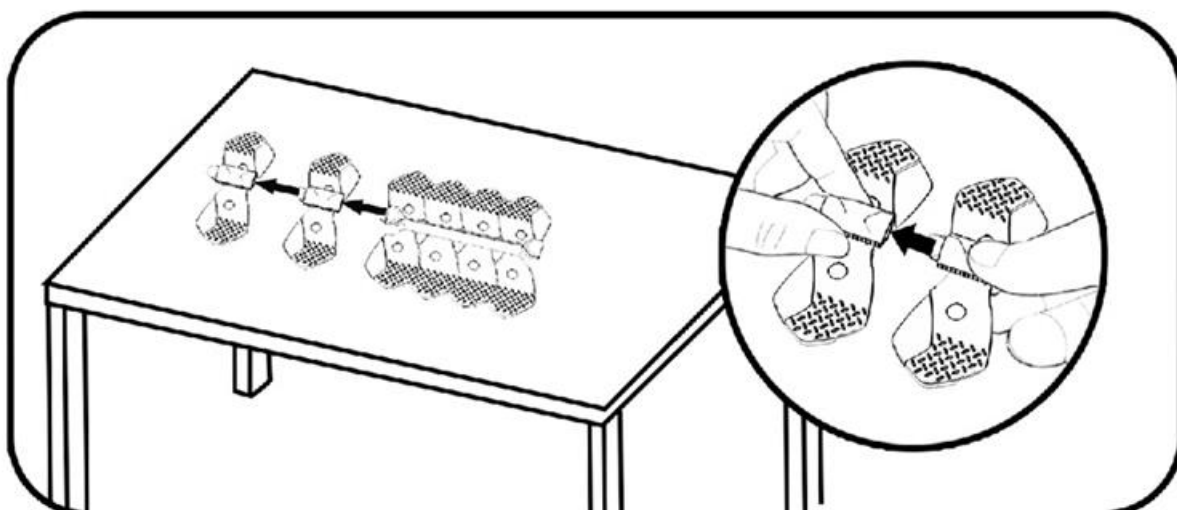



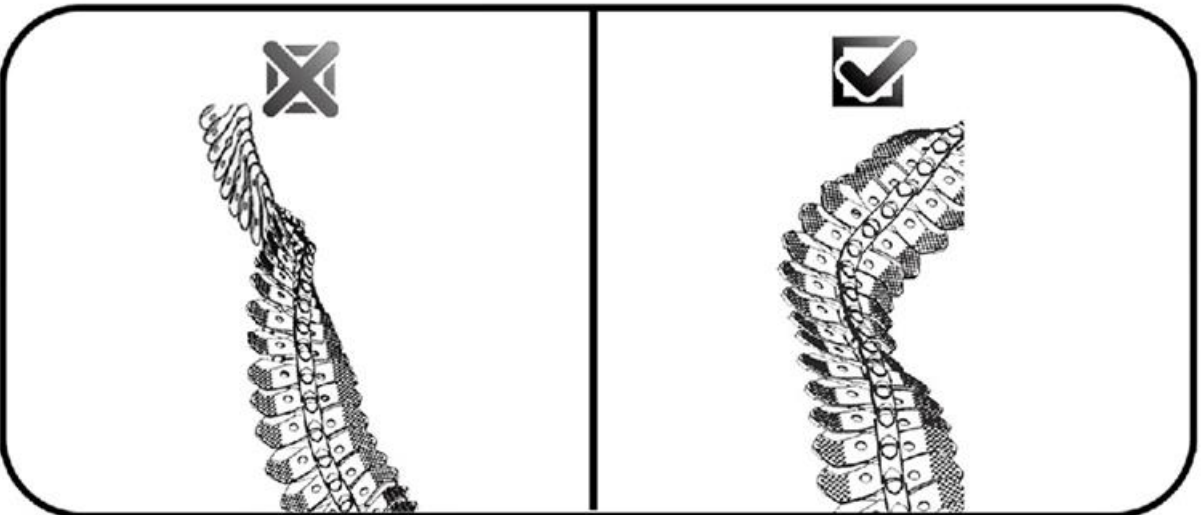
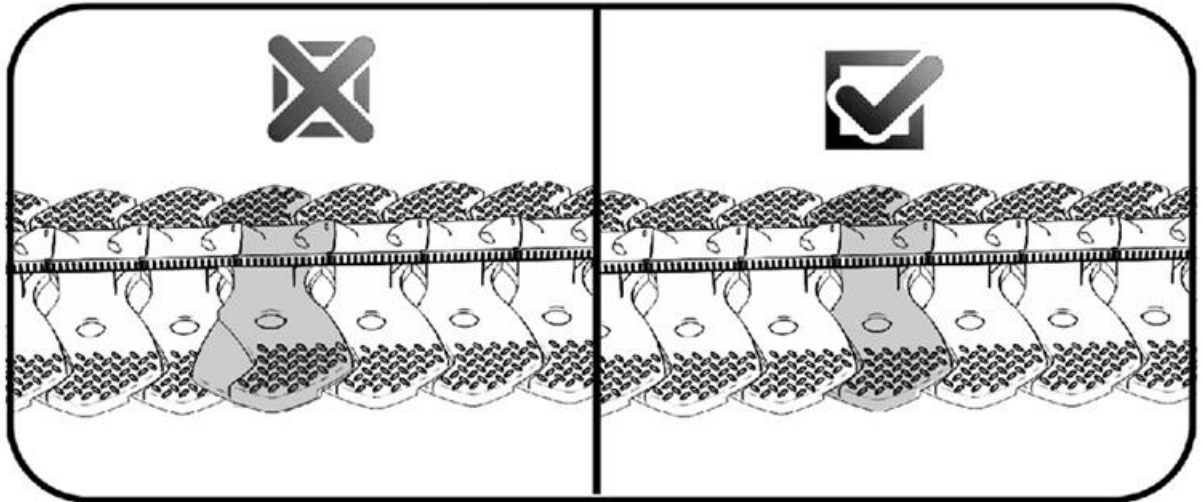
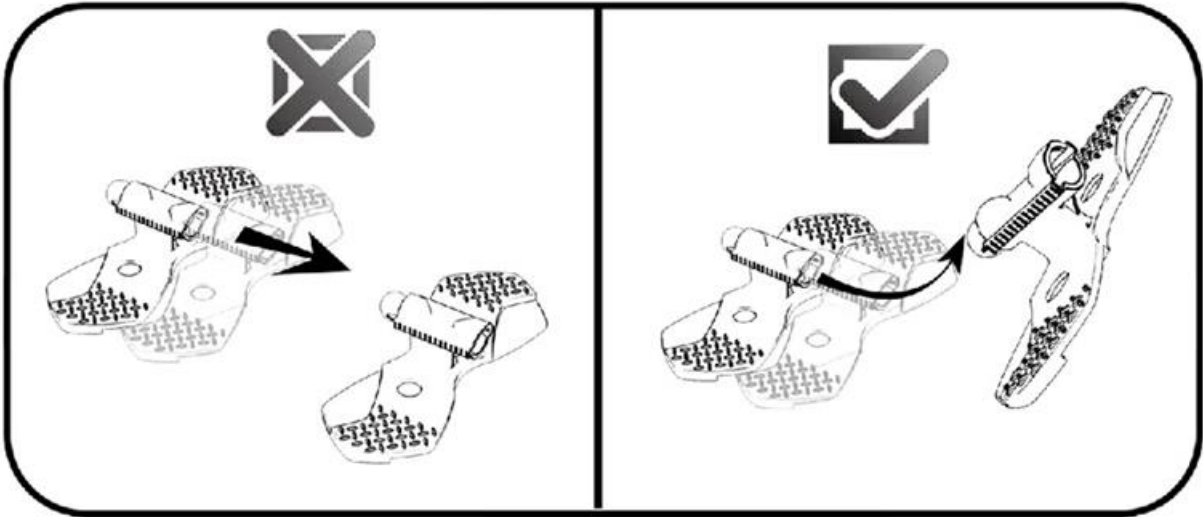

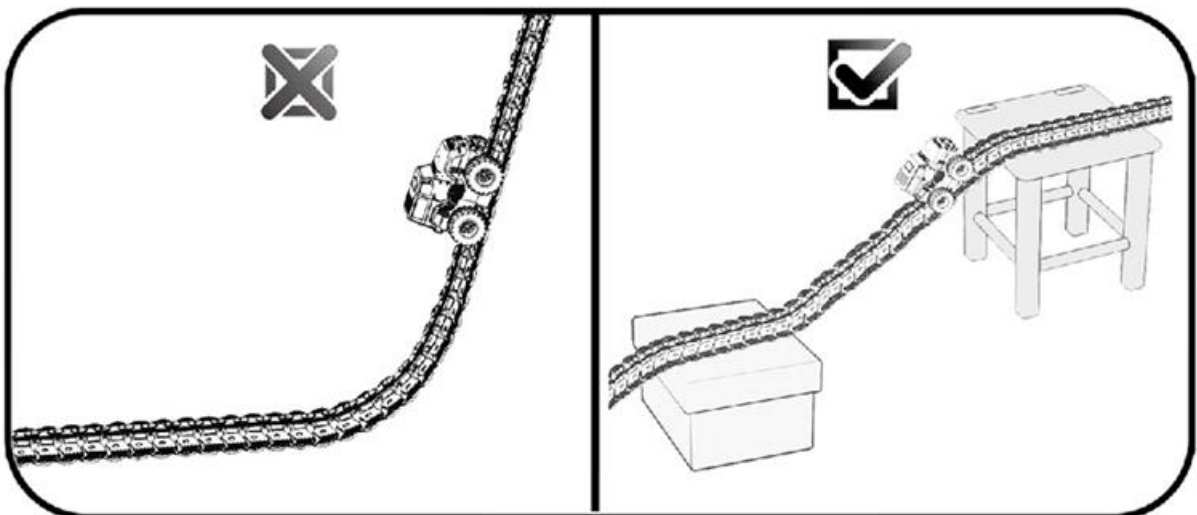
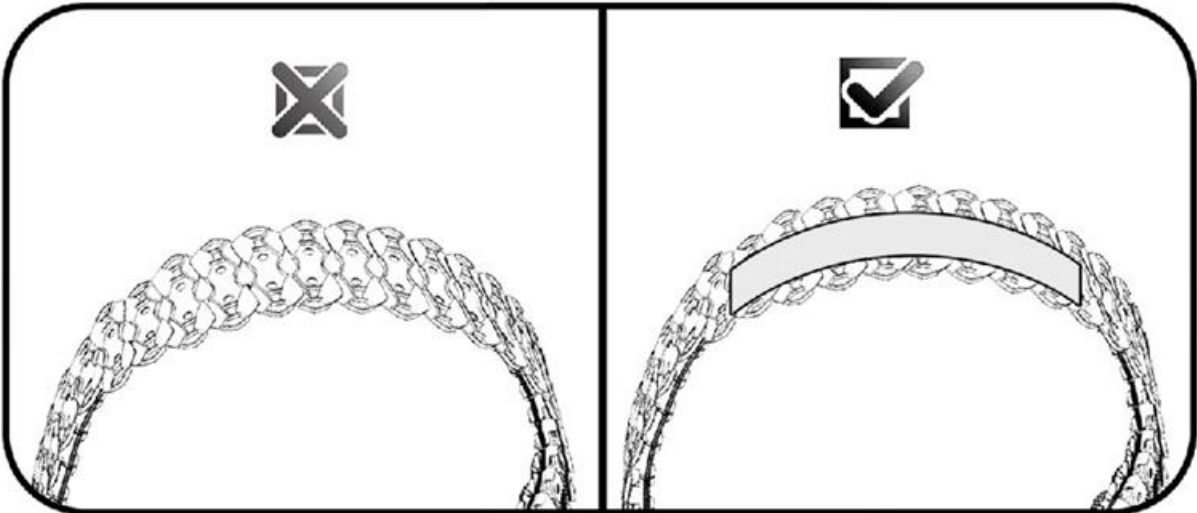
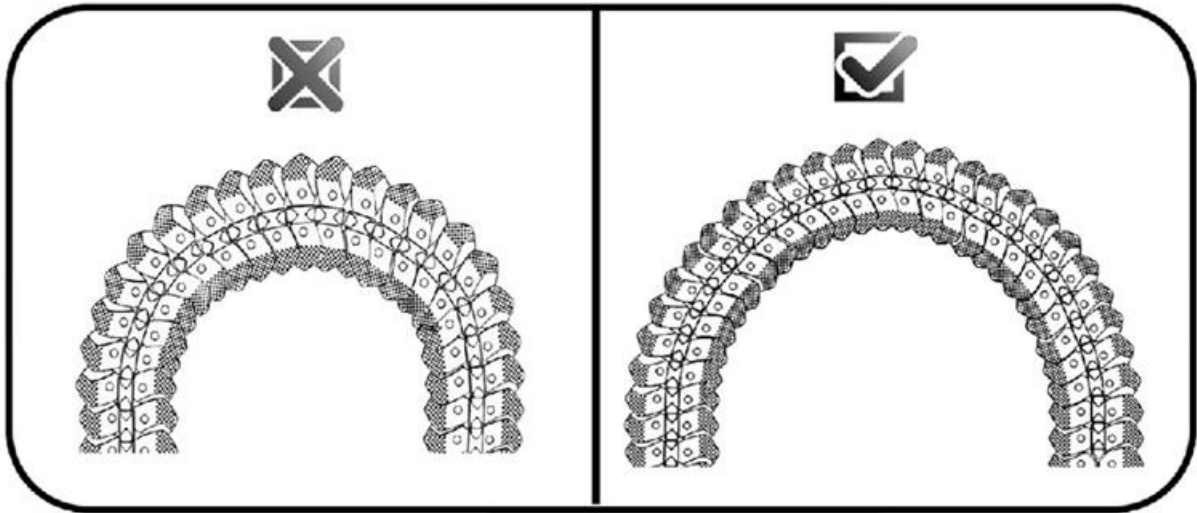

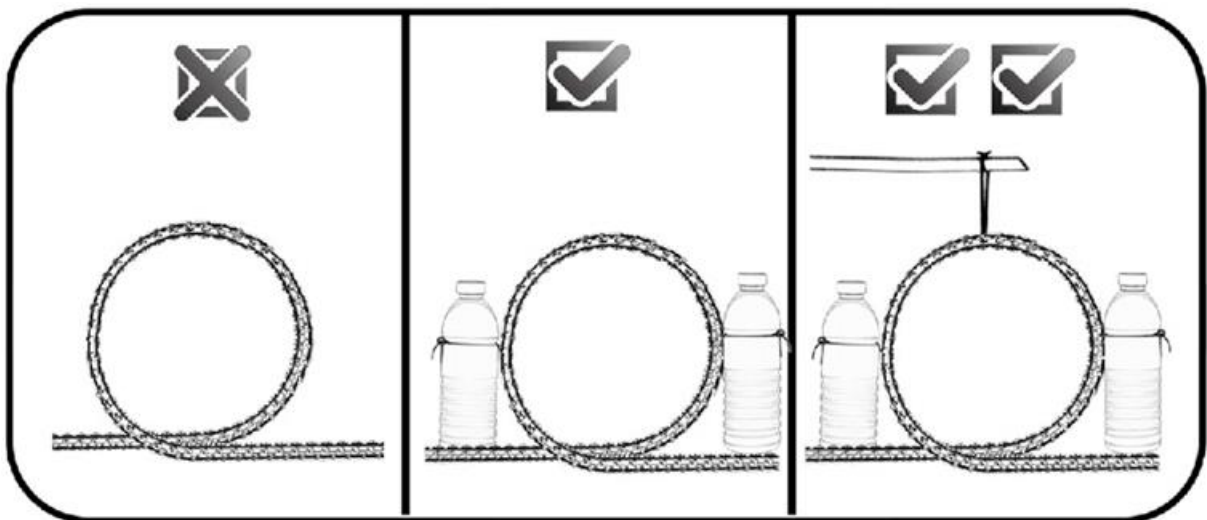
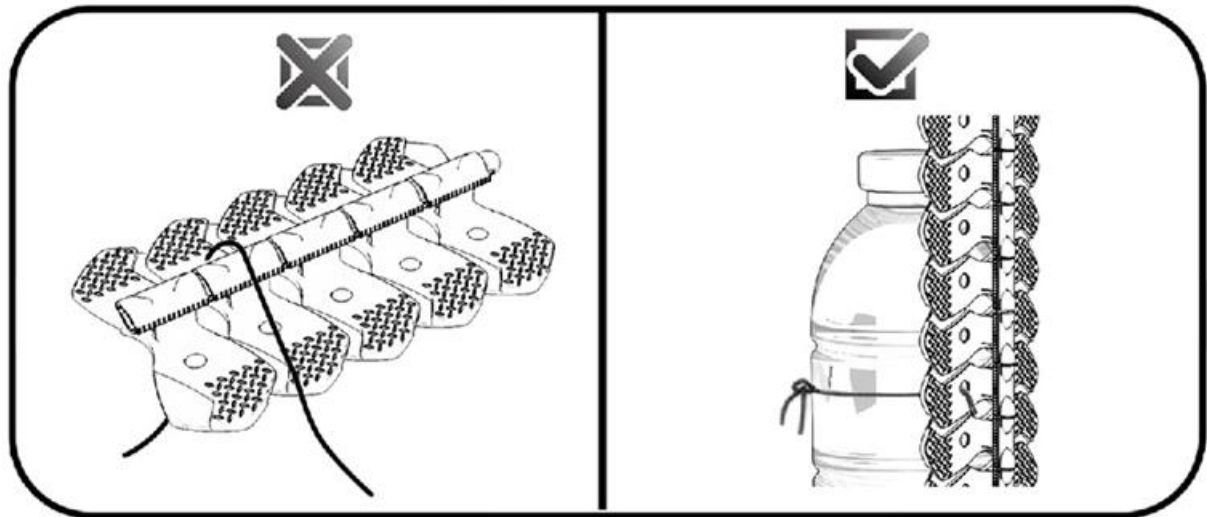
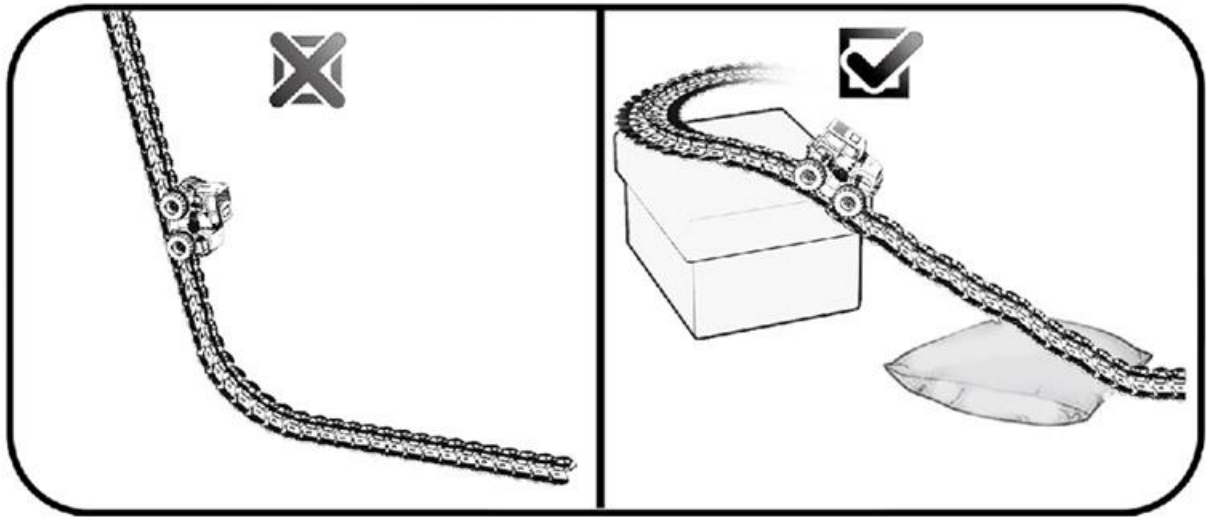

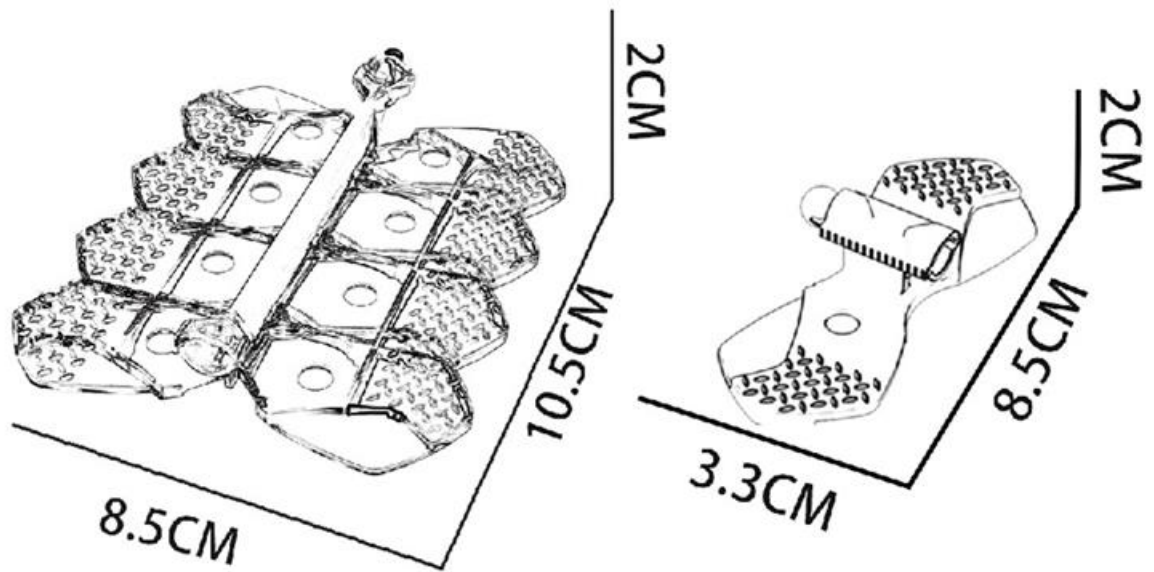

#### UTASÍTÁSOK A SZEMÉLTEADÁS ÉS HULLADÉKKEZELÉSHEZ:



Ez a címke azt jelenti, hogy a terméket nem szabad háztartási hulladékként eldobni az EU egész területén. Az esetleges környezeti vagy emberi egészségre káros hatások megelőzése érdekében. Felelősségteljesen használja újra, hogy elősegítse a materialitás fenntartható felhasználását. Ha vissza szeretné adni a használt eszközt, használja az eldobási és gyűjtési rendszert, vagy lépjen kapcsolatba azokkal a kiskereskedőkkel, akiktől a terméket megvásárolta. A kiskereskedő elfogadhatja a terméket környezetbarát újrahasznosításra.



A gyártó nyilatkozata arról, hogy a termék megfelel az érvényes EU irányelveknek.



## BG: LUMITRACK - РЪКОВОДСТВО ЗА ПОТРЕБИТЕЛЯ

### ЗАРЕЖДАНЕ НА БАТЕРИЯТА

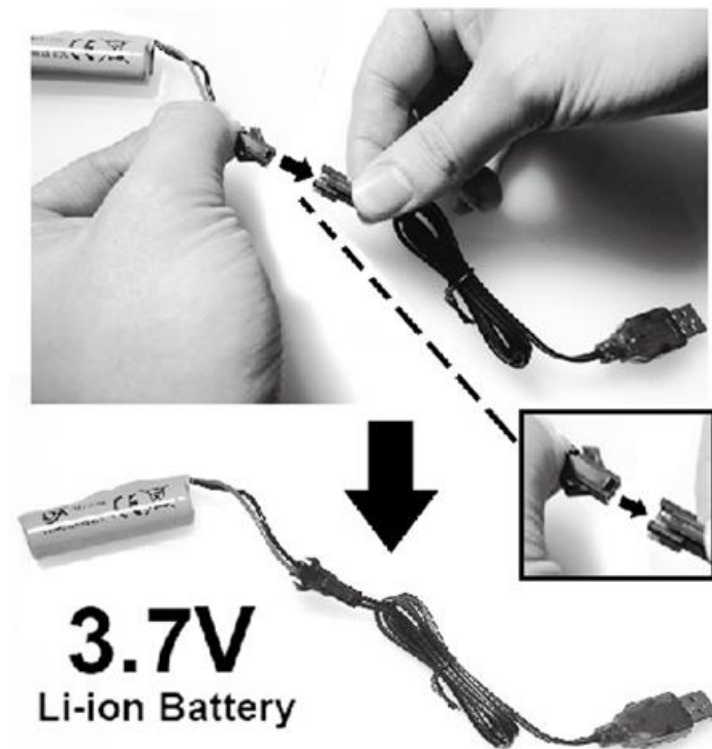

Литиево-йонната батерия 3,7 V и зарядното устройство са включени в опаковката на продукта.

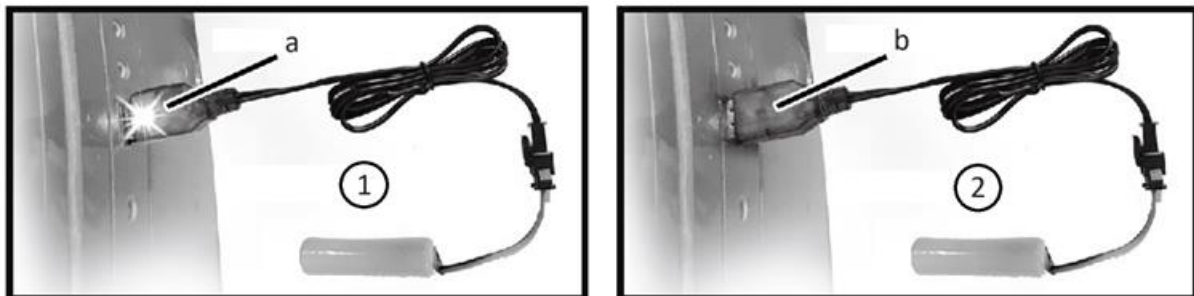

1. Зареждане на батерията

а) Ярки светлини

2. Напълно заредена батерия

б) Без светлини

При пълно зареждане продуктът свети в продължение на 70-90 минути.

ИНСТРУКЦИИ ЗА СГЛОБЯВАНЕ НА АВТОМОБИЛ

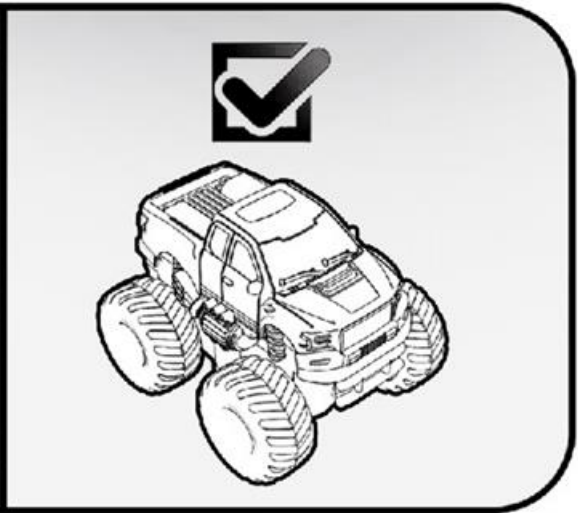
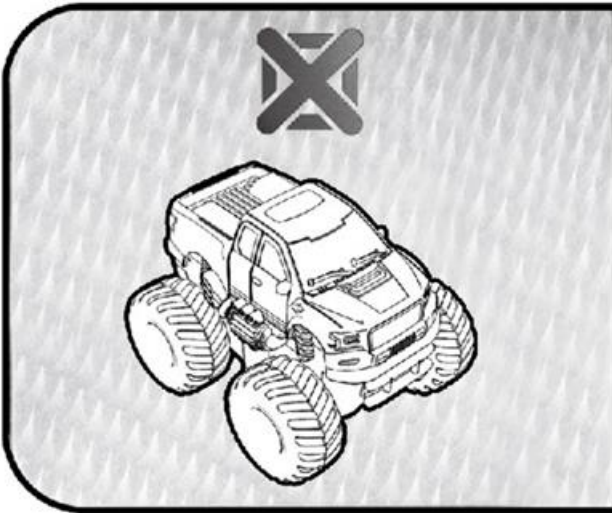
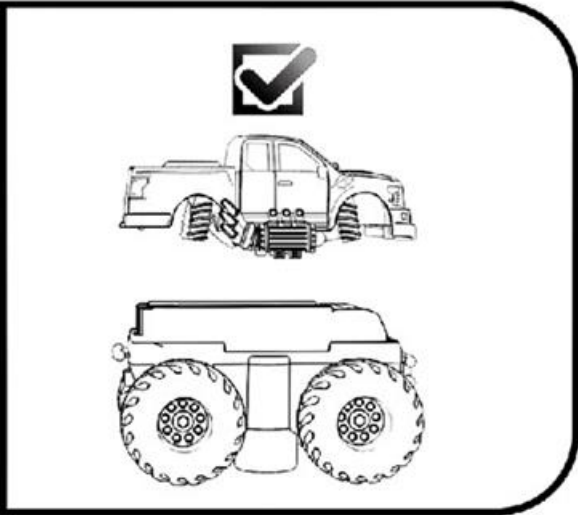
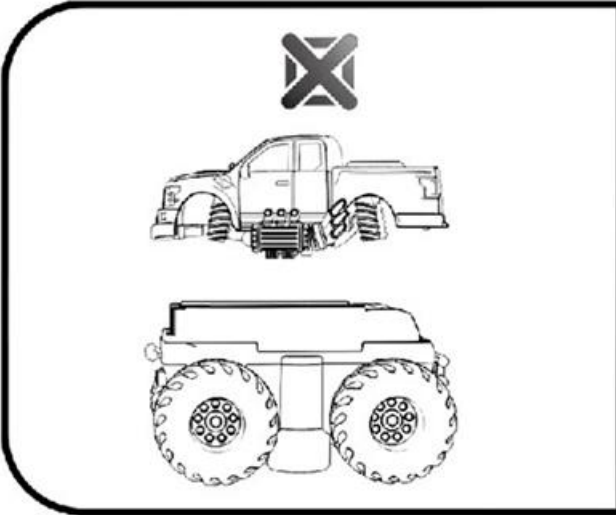
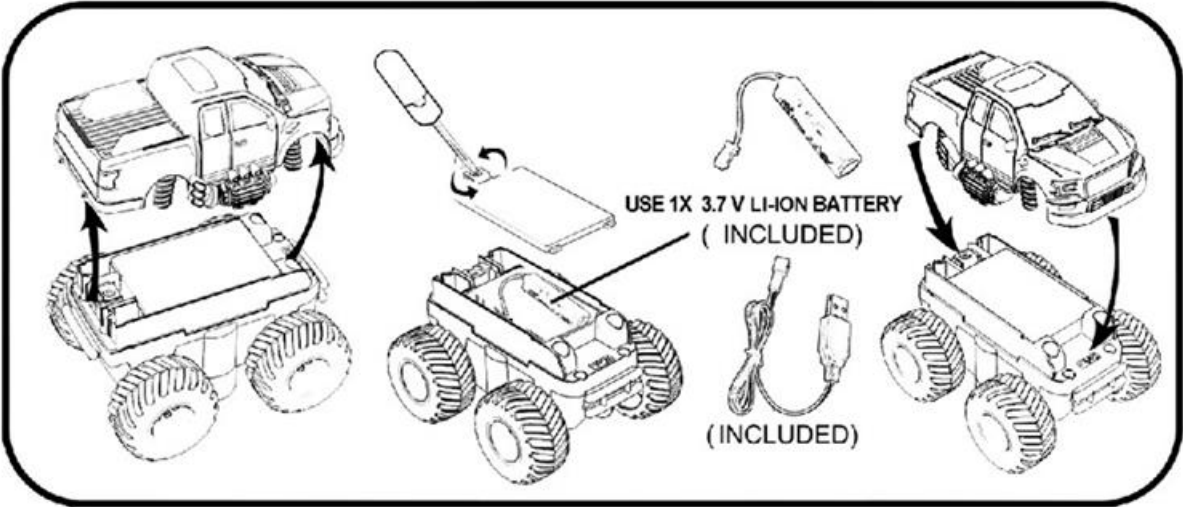

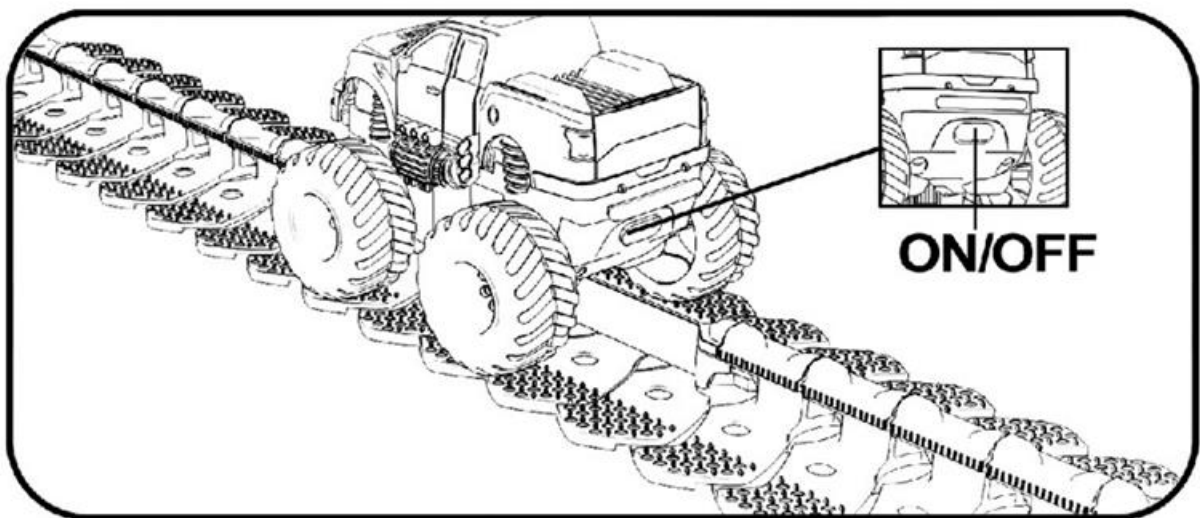
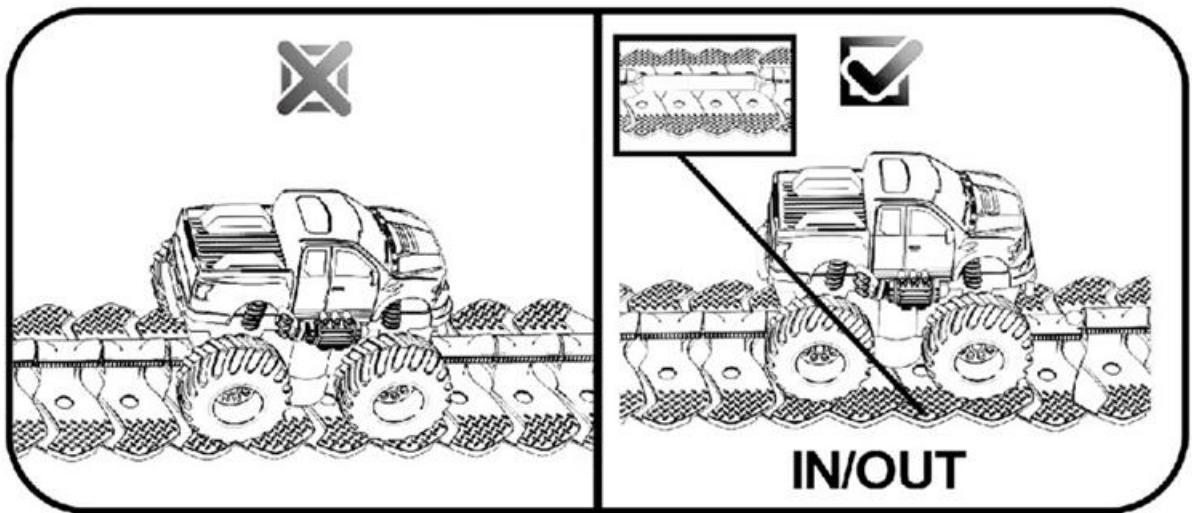

ПОСТАВЯНЕ НА ЕТИКЕТИ: АВТОМОБИЛ 1









ПОСТАВЯНЕ НА ЕТИКЕТИ: КАР 2

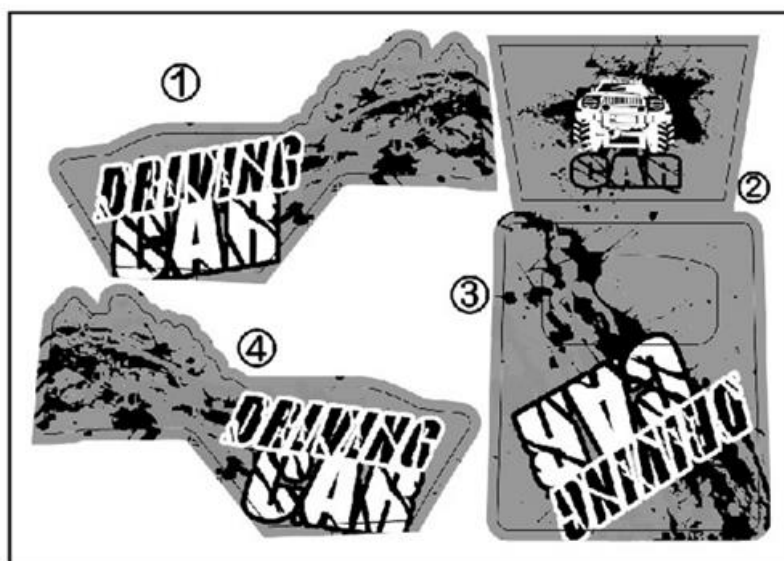



**СГЛОБЯВАНЕ НА ПИСТИ**

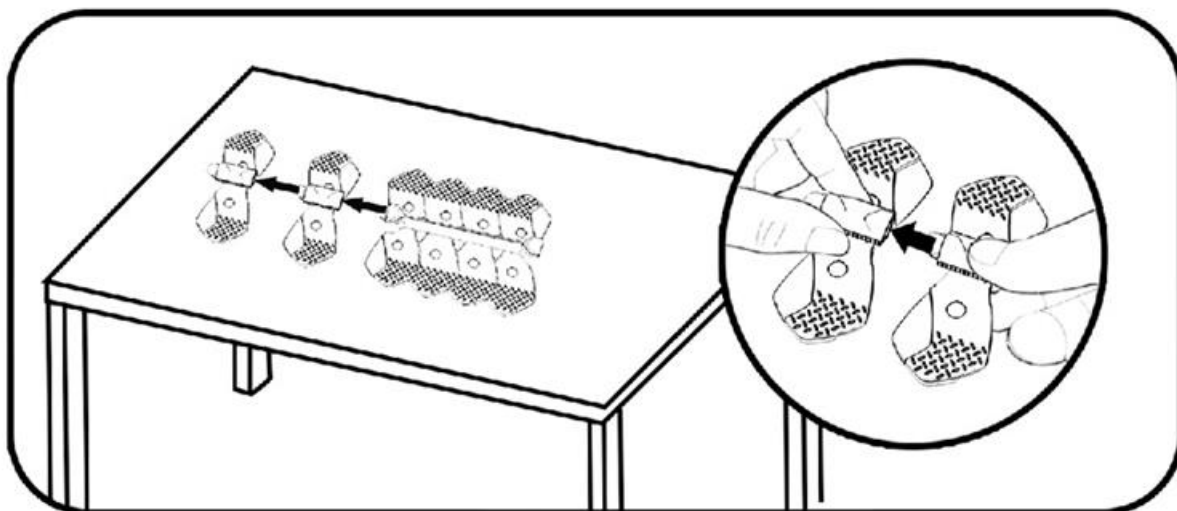

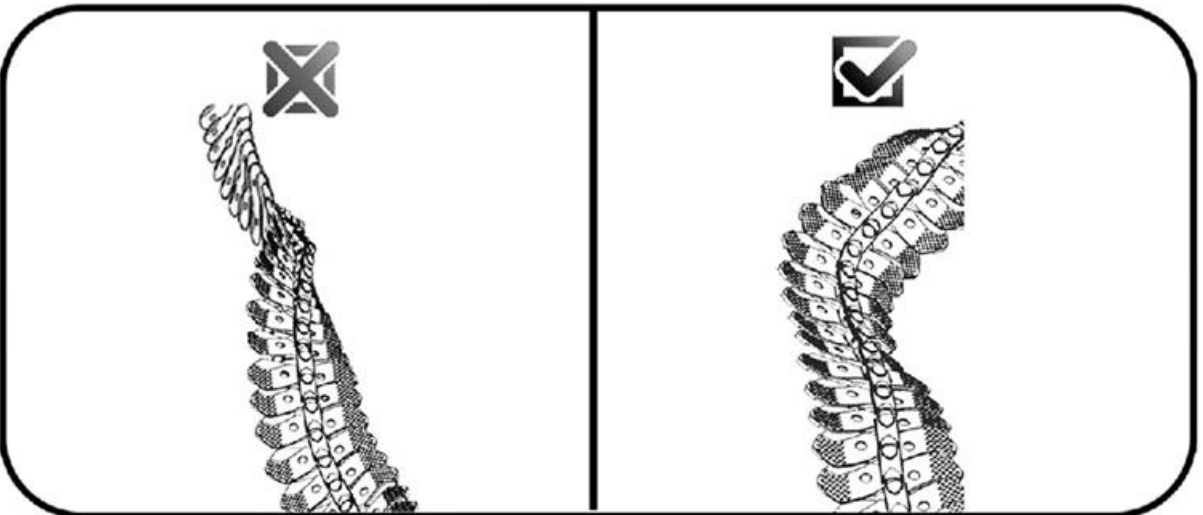
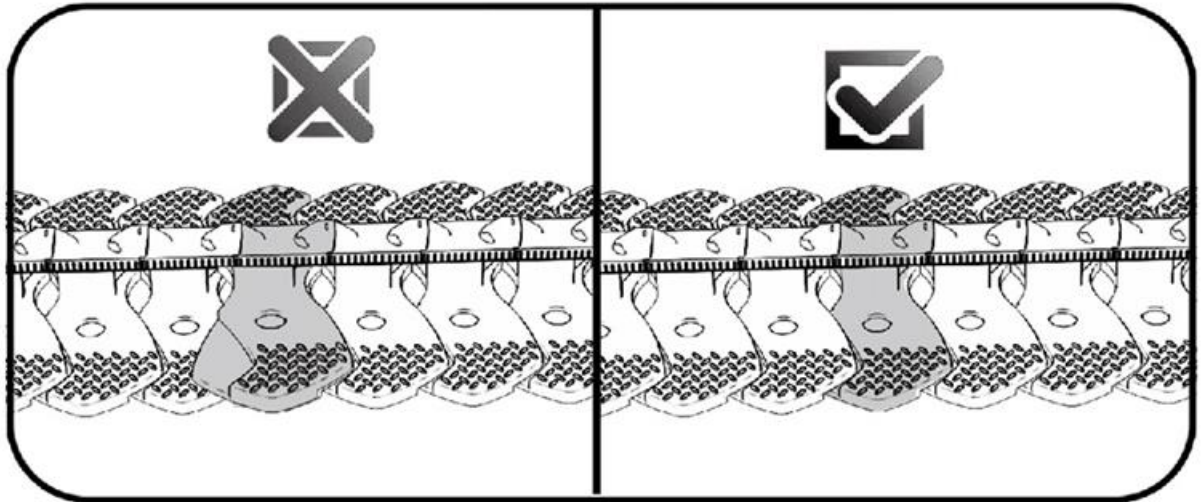
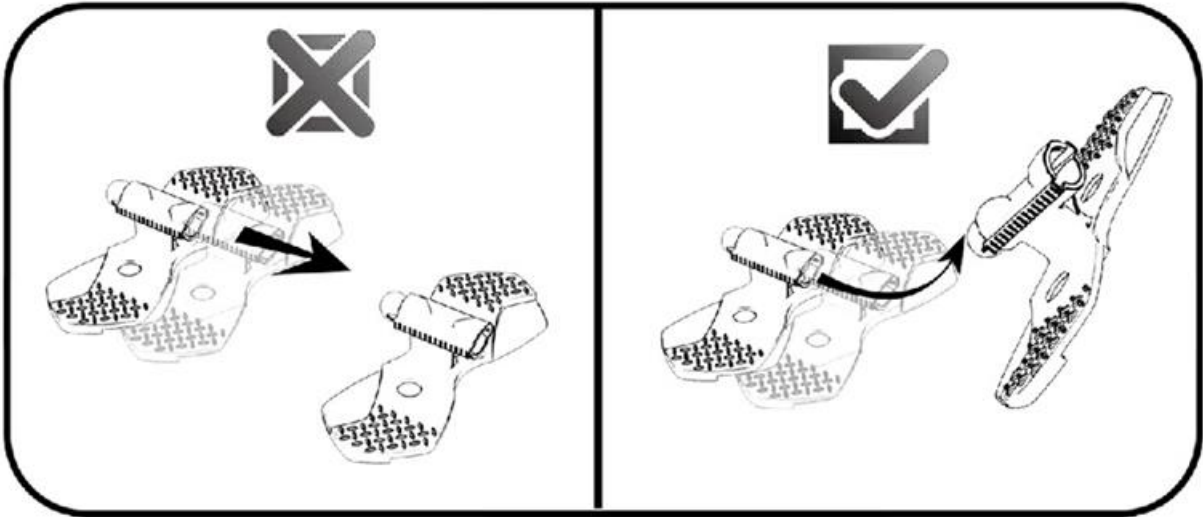

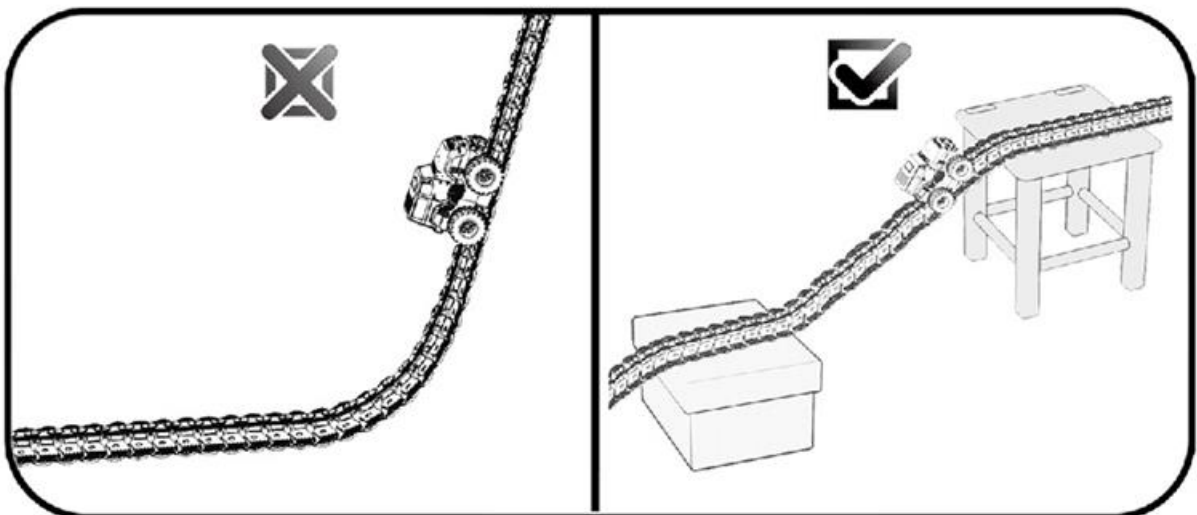
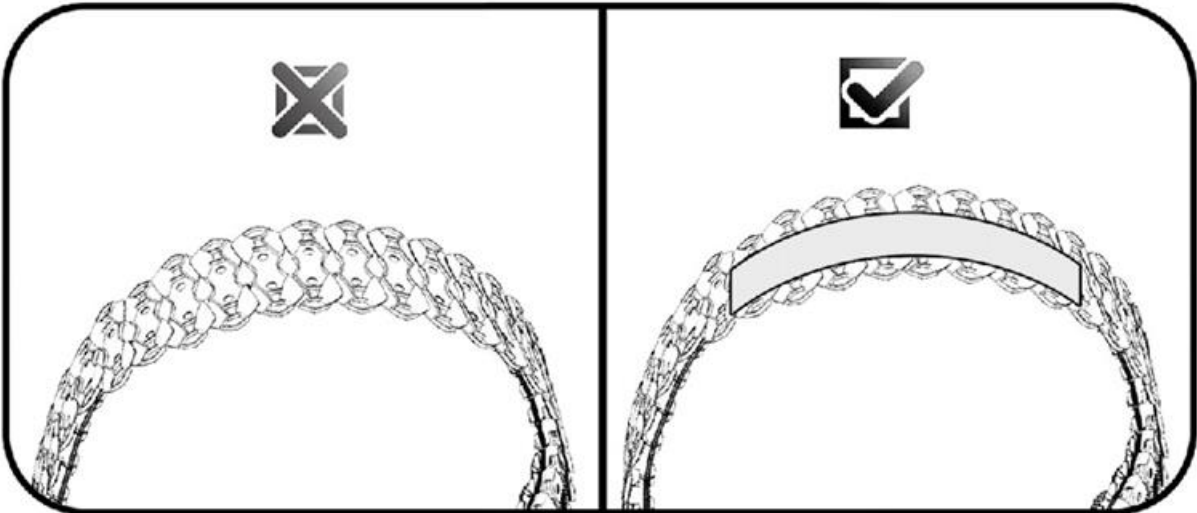
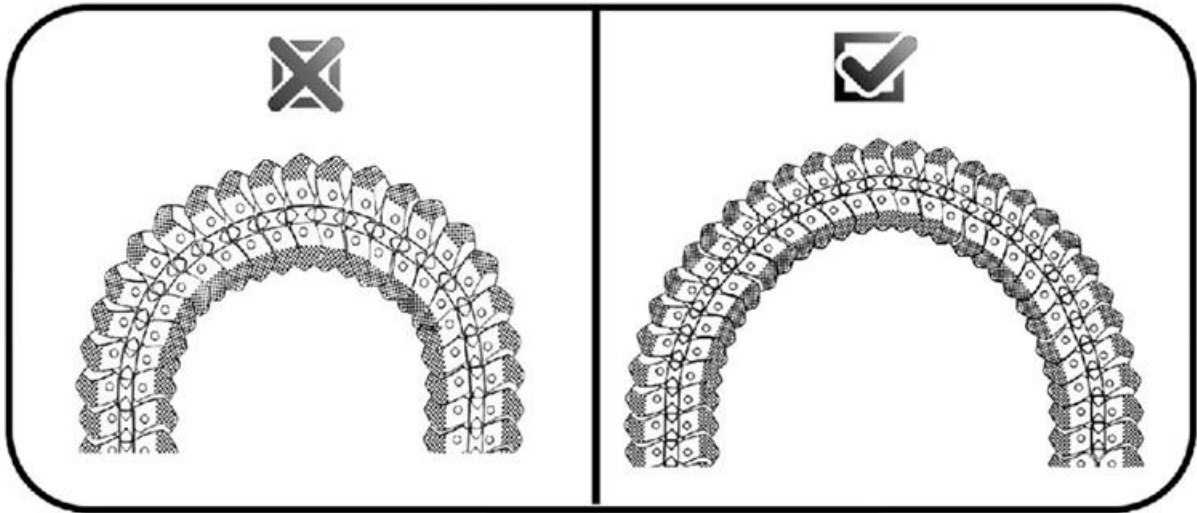



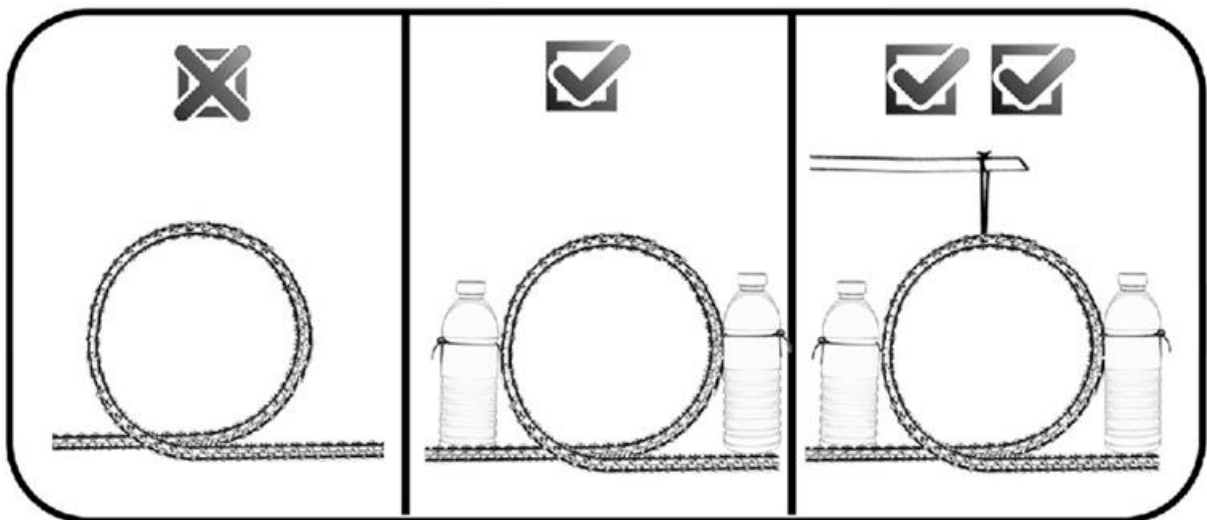
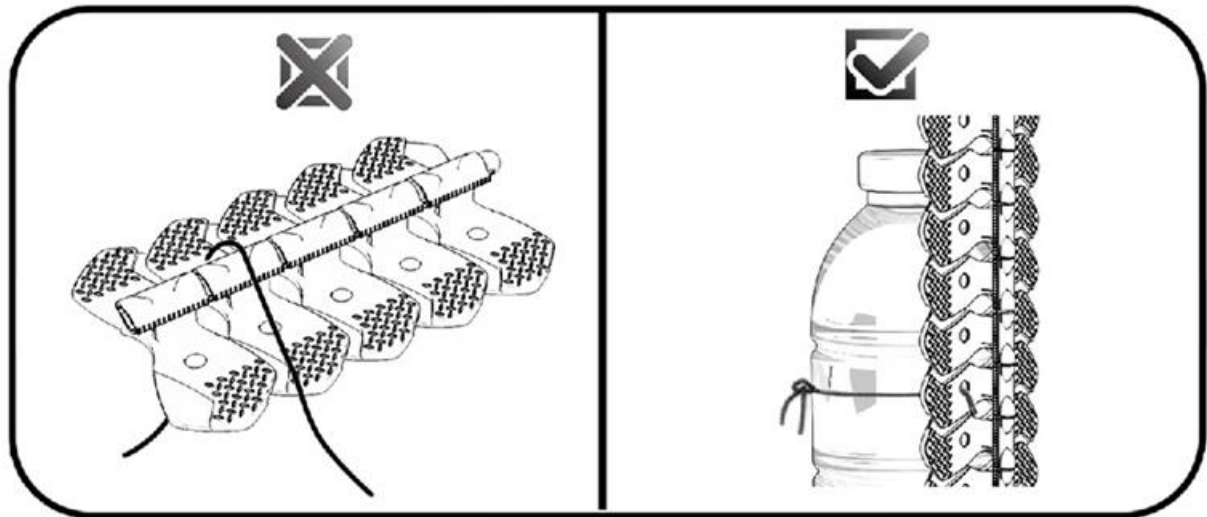
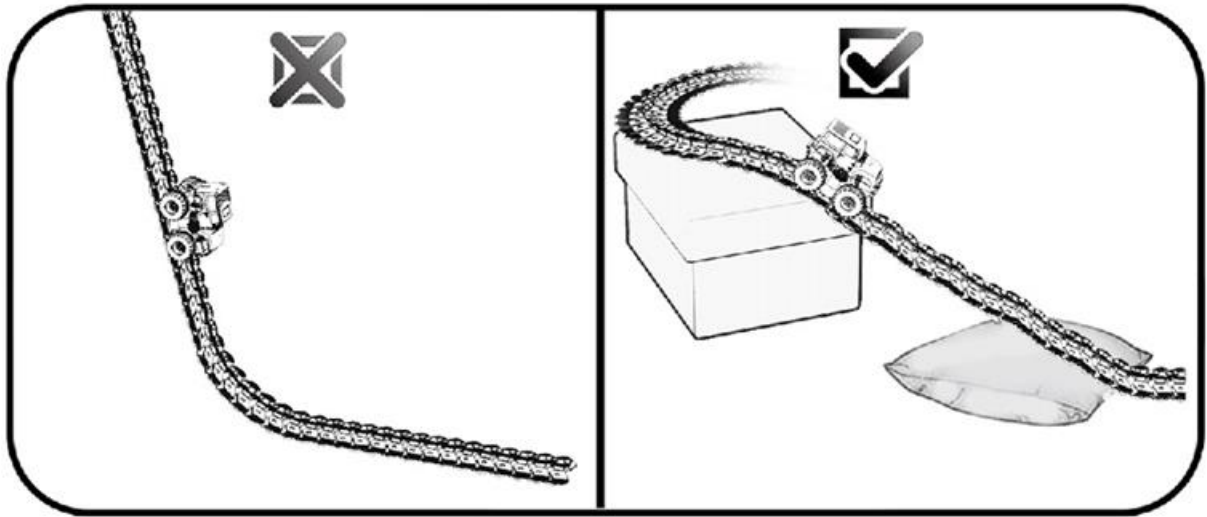

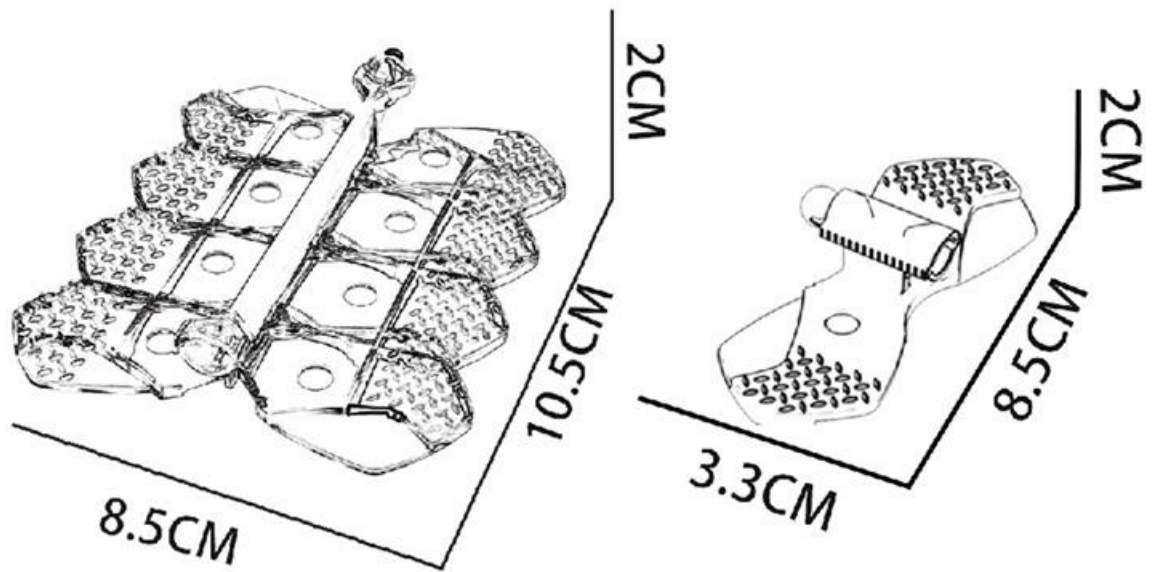

#### УКАЗАНИЯ ЗА РЕЦИКЛИРАНЕ И ИЗХВЪРЛЯНЕ:



Тази етикетка означава, че продуктът не може да се изхвърли като обикновен битов отпад в цялата ЕС. За предотвратяване на възможни вреди за околната среда или човешкото здраве от неконтролирано изхвърляне на отпадъци. Рециклирайте отговорно, за да се подпомогне устойчивата употреба на материални ресурси. Ако искате да върнете употребявано устройство, използвайте системата за събиране и събиране или се свържете с търговеца, от когото сте закупили продукта. Търговецът може да приеме продукта за екологично безопасно рециклиране.



Декларация от производителя, че продуктът отговаря на изискванията на съответните директиви на ЕС.

## LV: LUMITRACK - LIETOTĀJA ROKASGRĀMATA

### AKUMULATORA UZLĀDE



3,7 V litija jonu akumulators un lādētājs ir iekļauti produkta iepakojumā.

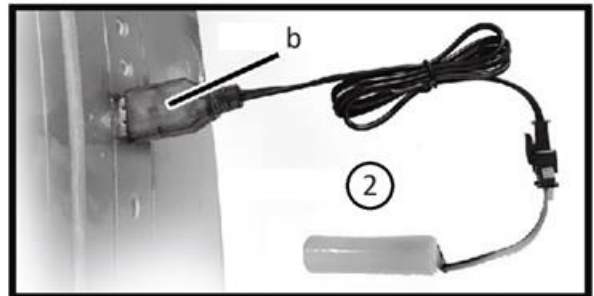
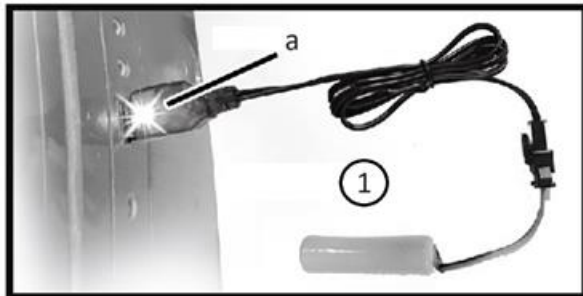

1. Akumulatora uzlāde

a) Spilgtas gaismas

2. Pilnībā uzlādēts akumulators

b) nav gaismas

Pilnībā uzlādēts izstrādājums spīd 70-90 minūtes.

AUTOMAŠĪNAS MONTĀŽAS INSTRUKCIJA

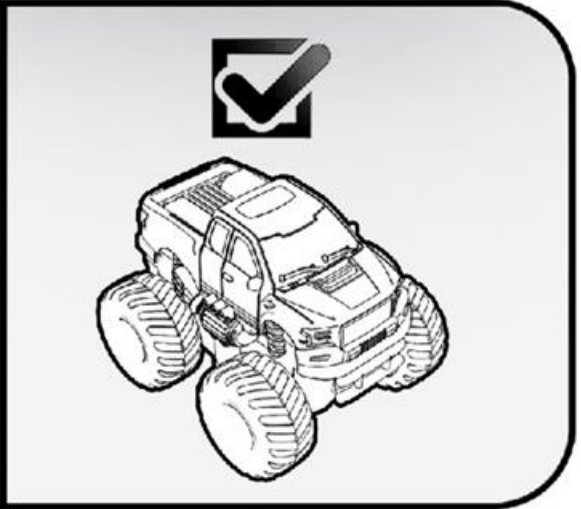
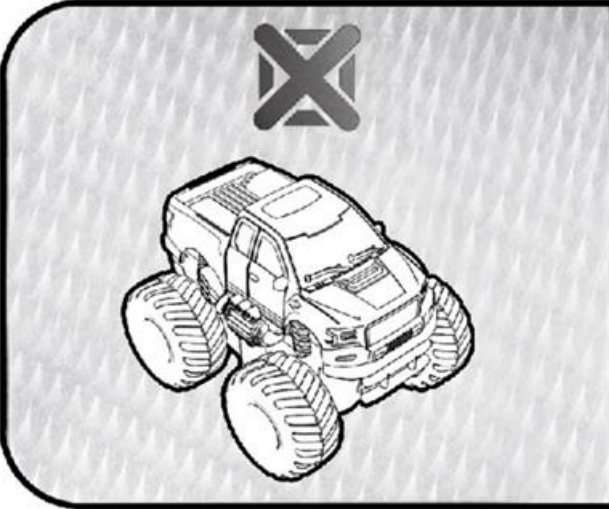
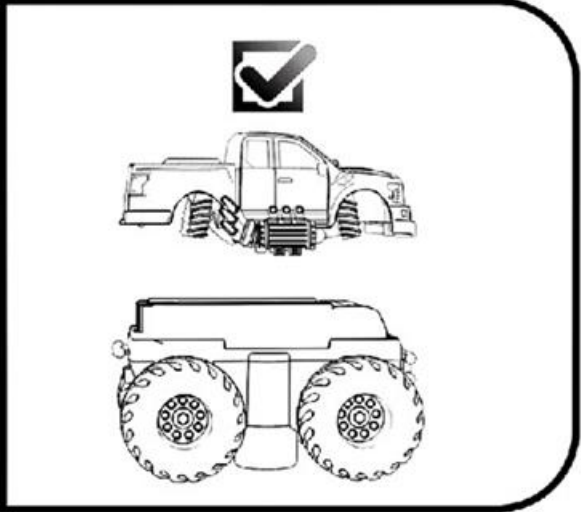
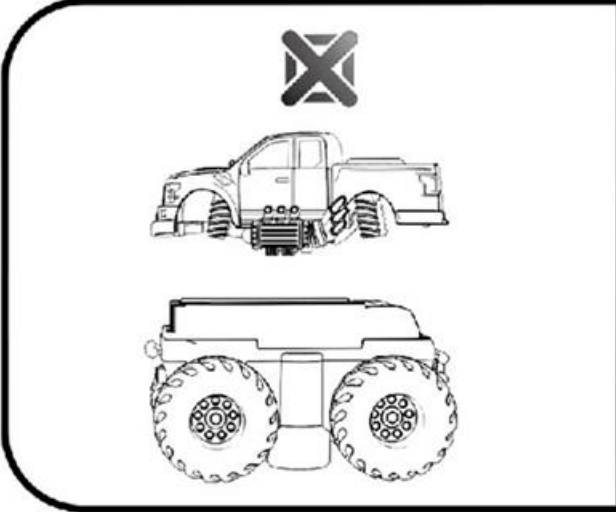
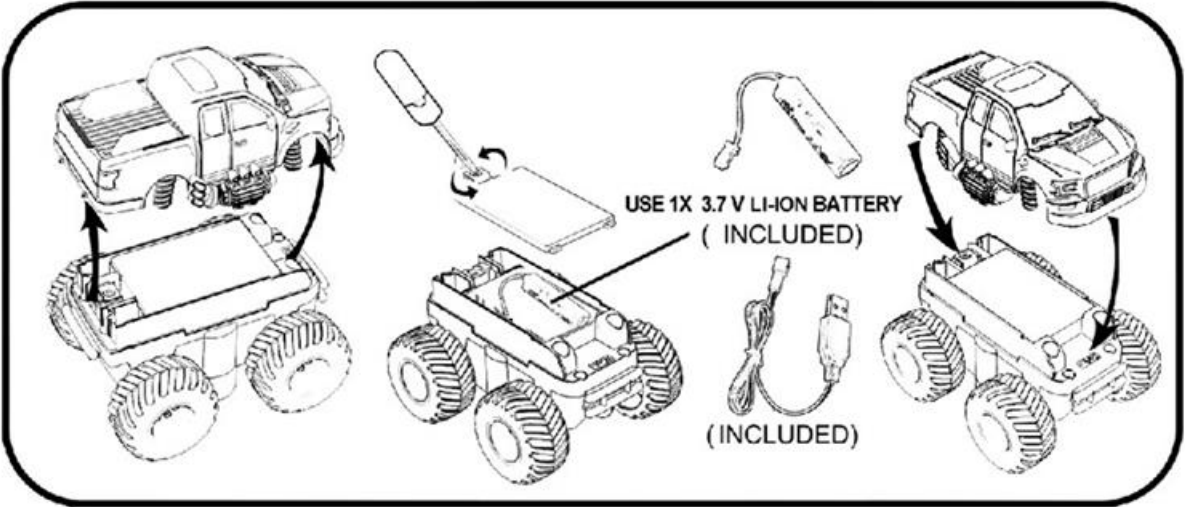



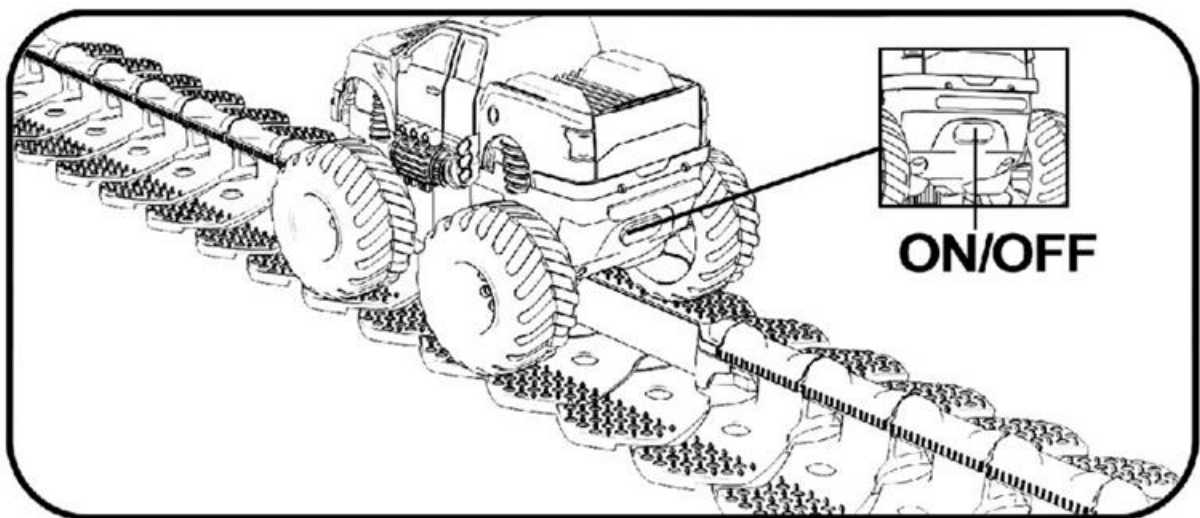
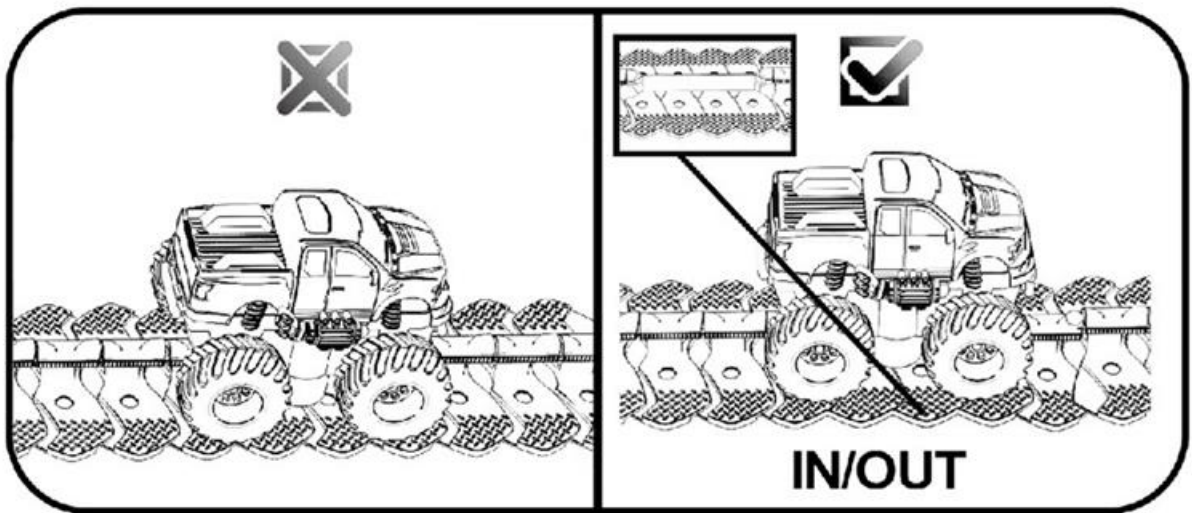

ETIĶEŠU IZVIETOJUMS: AUTOMOBILIS 1





ETIĶEŠU IZVIETOJUMS: AUTOMAŠĪNAS 2: UZLĪMJU IZVIETOJUMS: AUTOMAŠĪNAS 2

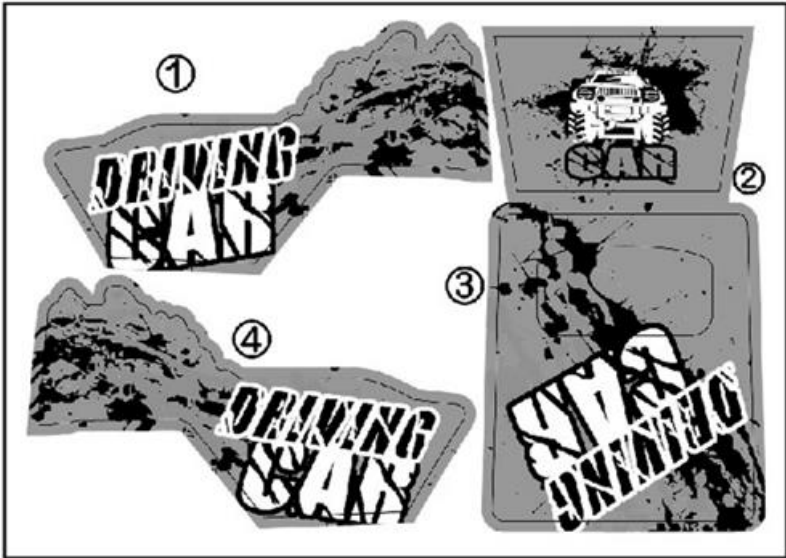





SLIEŽU CEĻU MONTĀŽA

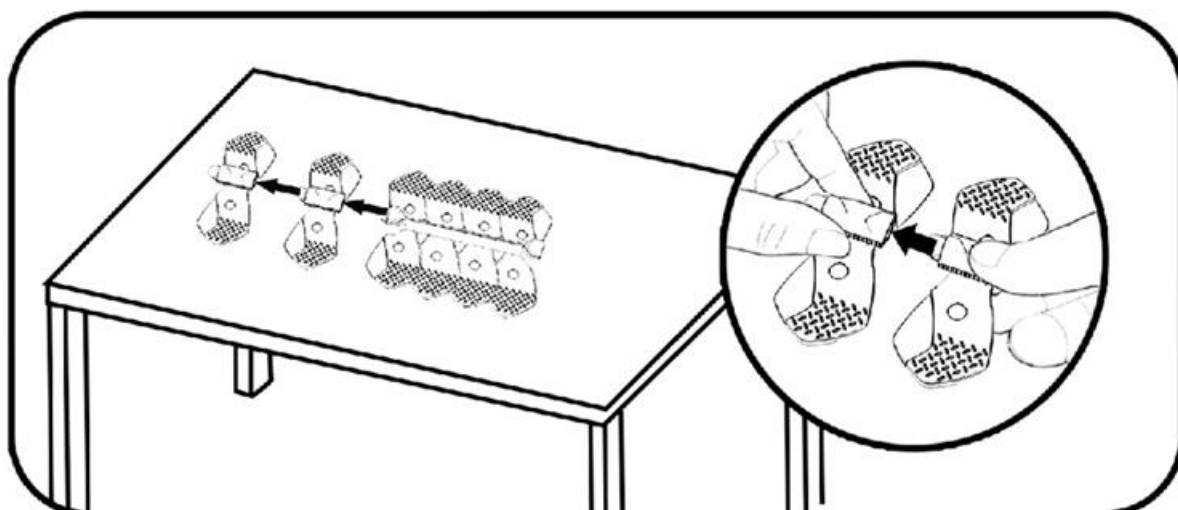



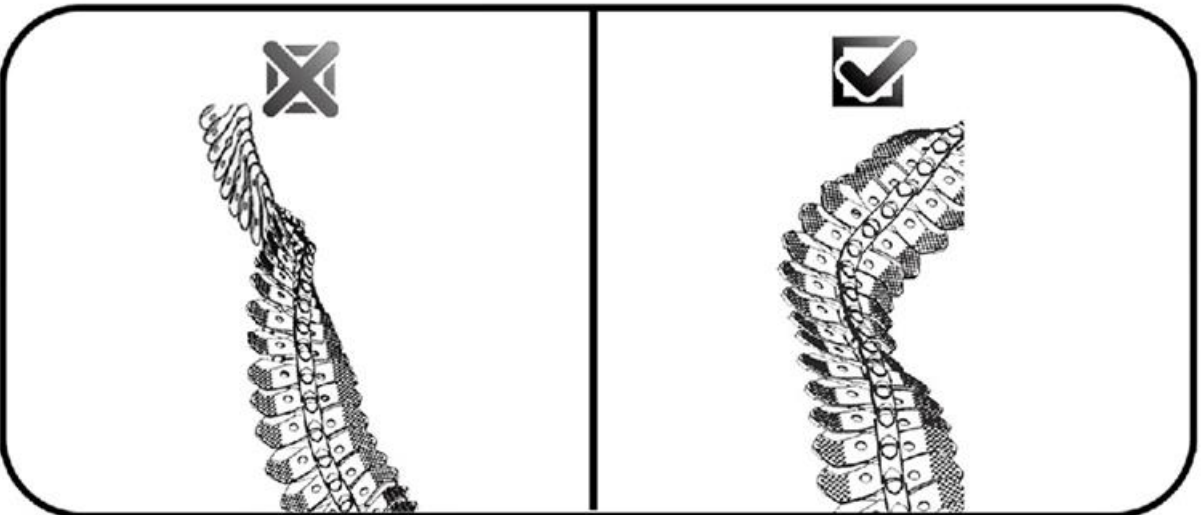
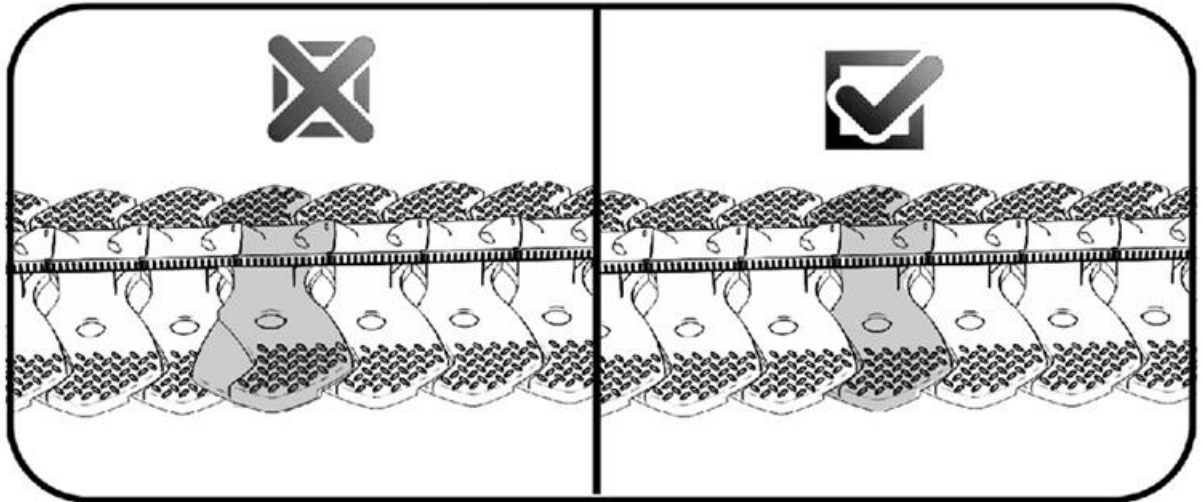
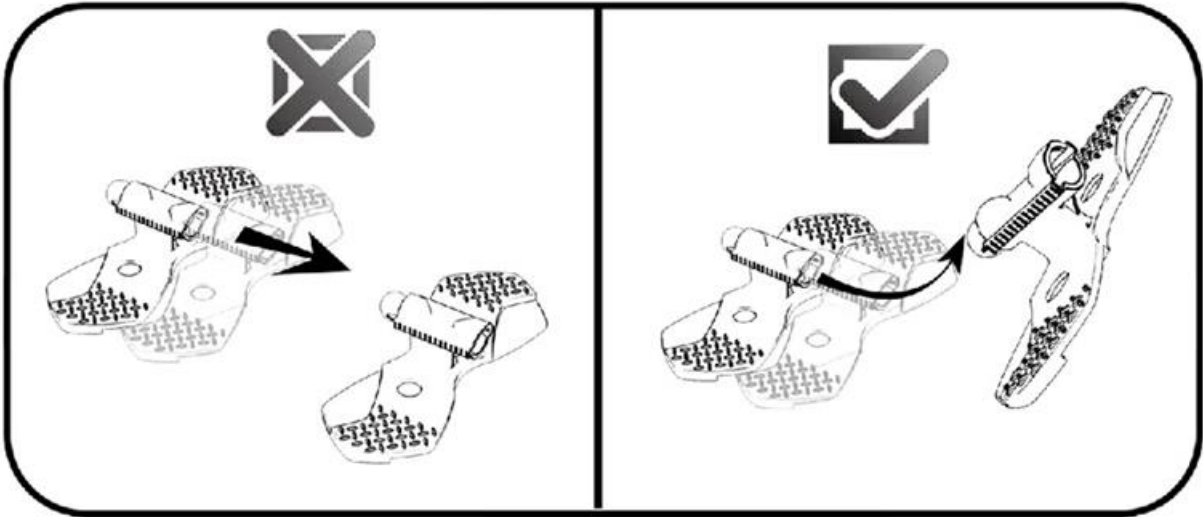

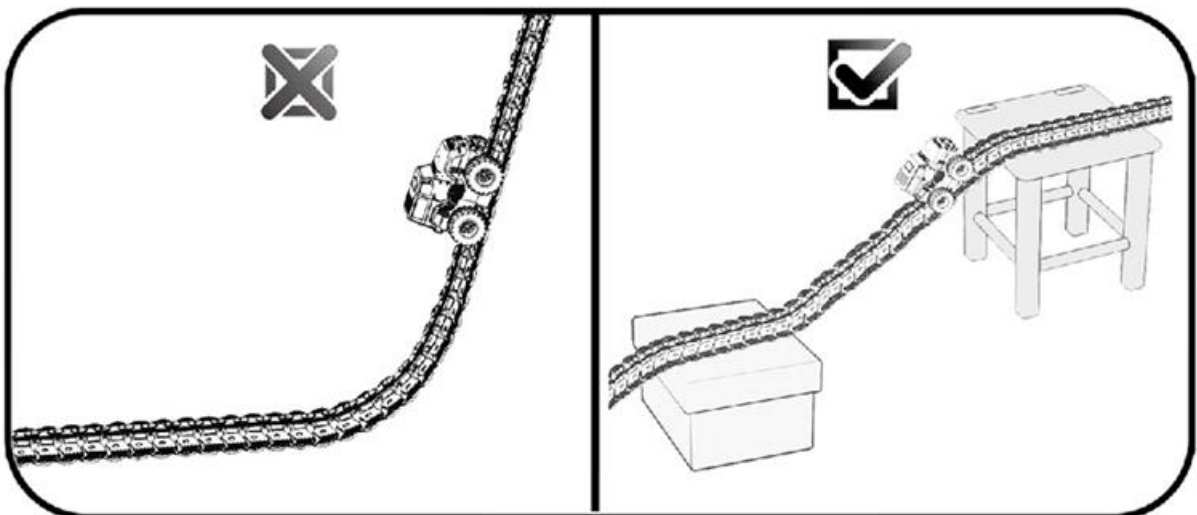
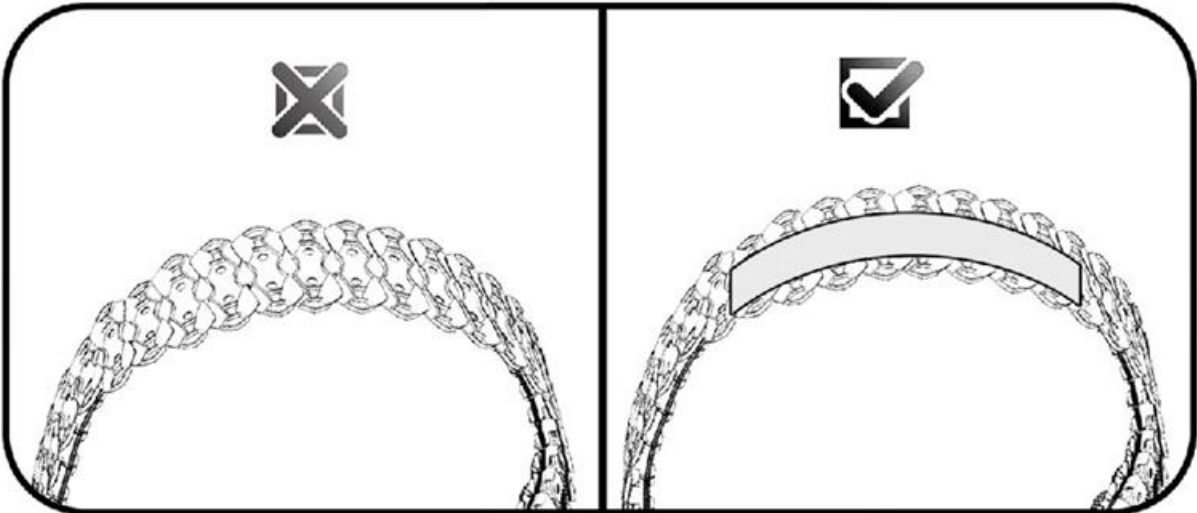
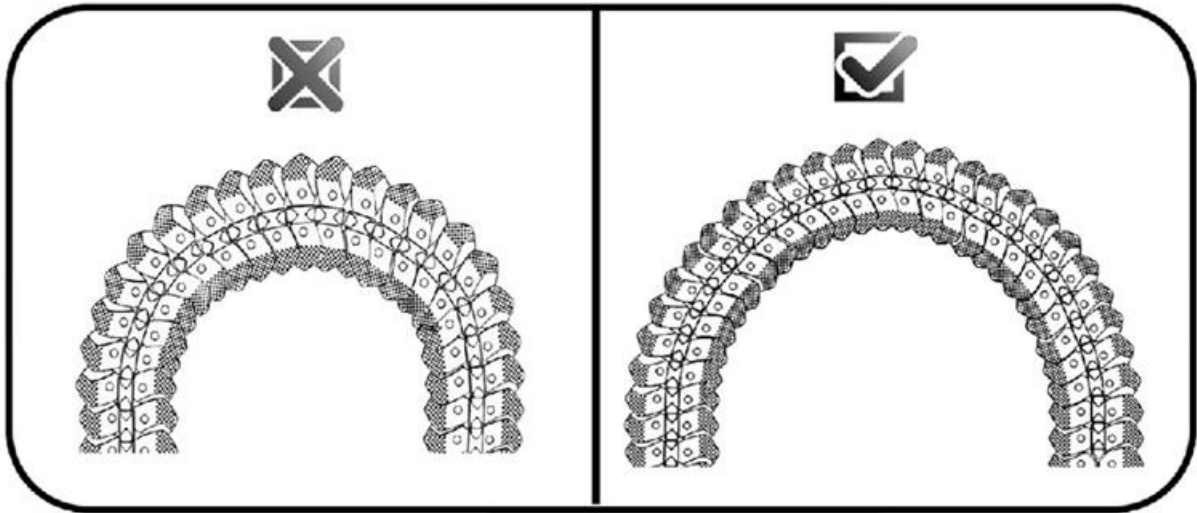

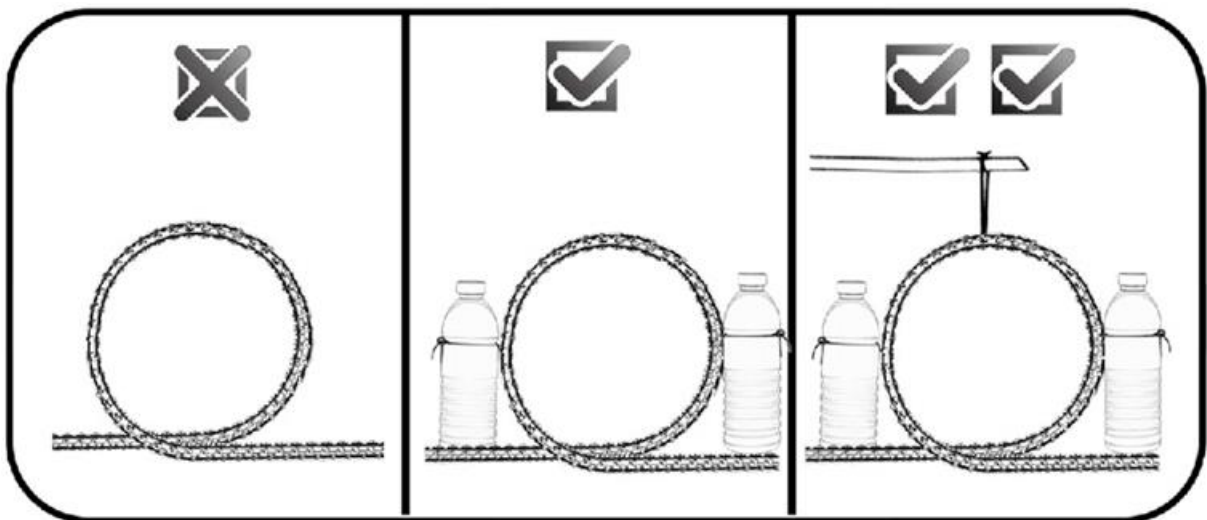
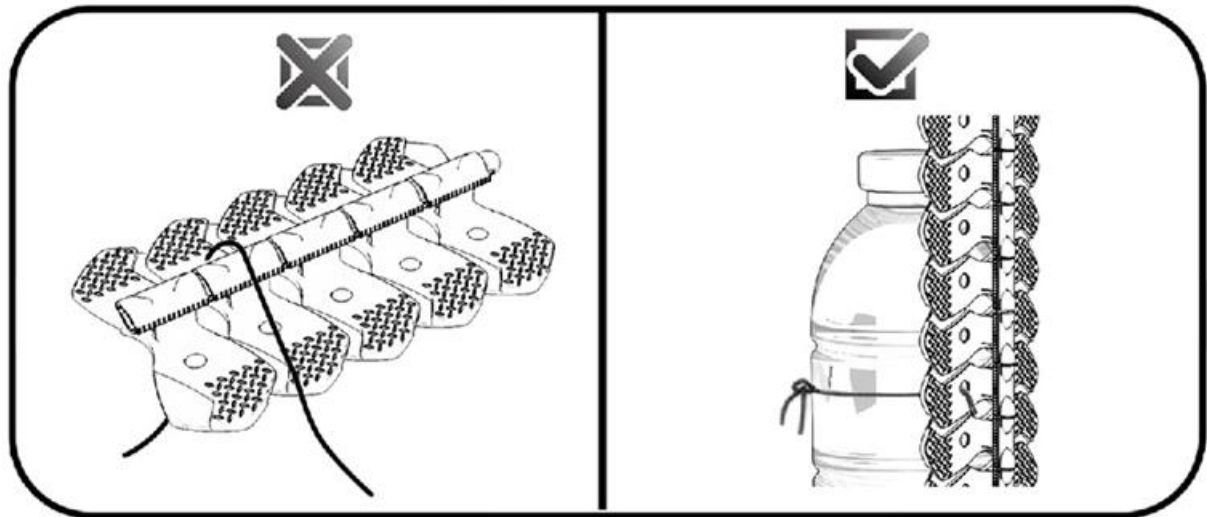
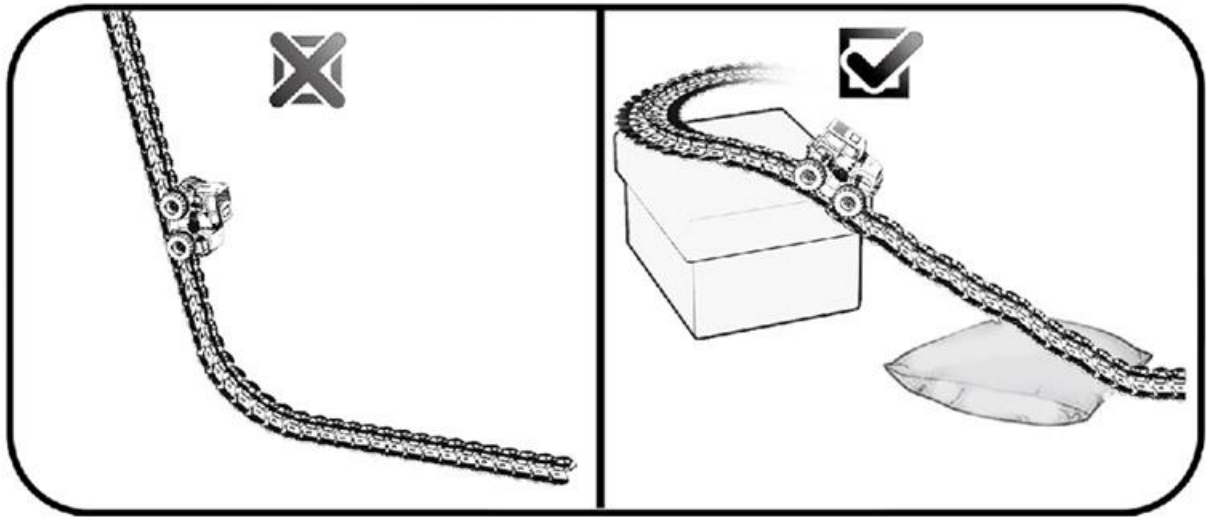

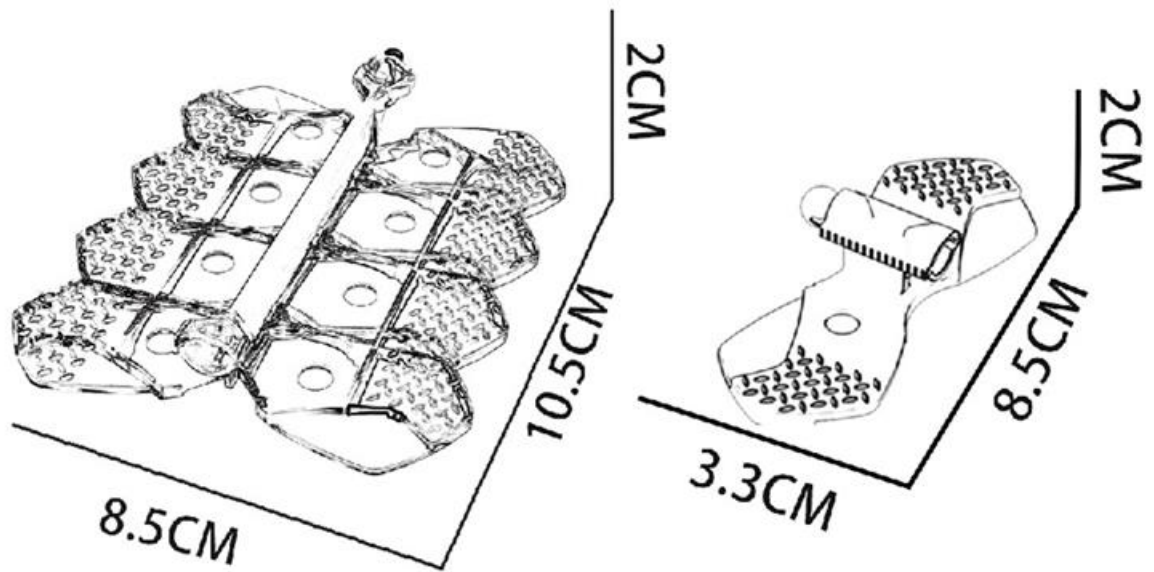

#### INSTRUKCIJAS PAR PĀRSTRĀDI UN IZMETIENU:



Šī etiķete nozīmē, ka produkts nedrīkst tikt izmesti kā parasts sadzīves atkritums visā ES. Lai novērstu iespējamus kaitējumus vides vai cilvēku veselībai no nekontrolētas atkritumu izgāšanas. Pārstrādājiet atbildīgi, lai veicinātu materiālu resursu ilgtspējīgu izmantošanu. Ja vēlaties atgriezt lietoto ierīci, izmantojiet atdevi un kolekcijas sistēmu vai sazinieties ar mazumtirgotāju, no kura iegādājāties produktu. Mazumtirgotājs var pieņemt produktu ekoloģiski drošai pārstrādei.



Ražotāja deklarācija, ka produkts atbilst attiecīgajām ES direktīvām.



## LT: LUMITRACK - NAUDOTOJO VADOVAS

### AKUMULIATORIAUS ĮKROVIMAS

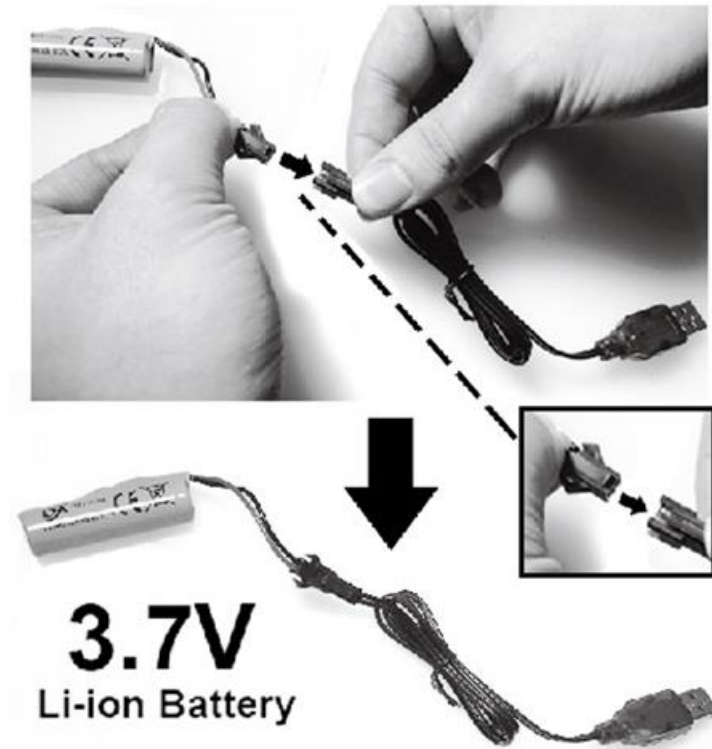

3,7 V ličio jonų akumuliatorius ir įkroviklis yra gaminio pakuotėje.

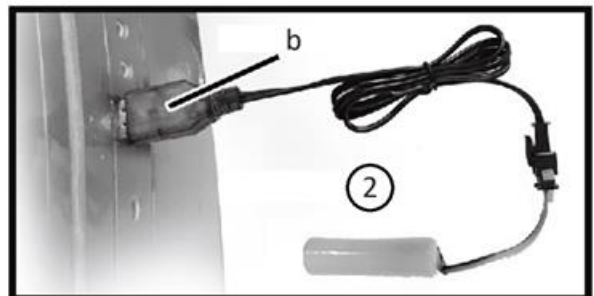
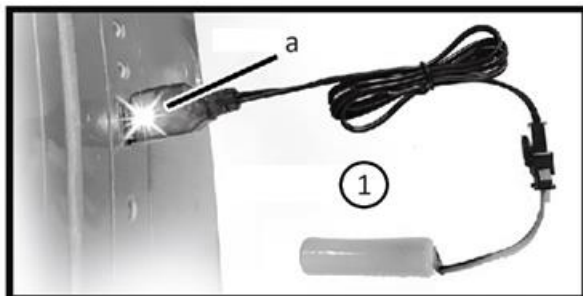

1. Akumuliatoriaus įkrovimas

a) Ryškios šviesos

2. Visiškai įkrautas akumuliatorius

b) nėra šviesų

Visiškai įkrautas gaminys šviečia 70-90 minučių.

AUTOMOBILIO SURINKIMO INSTRUKCIJOS

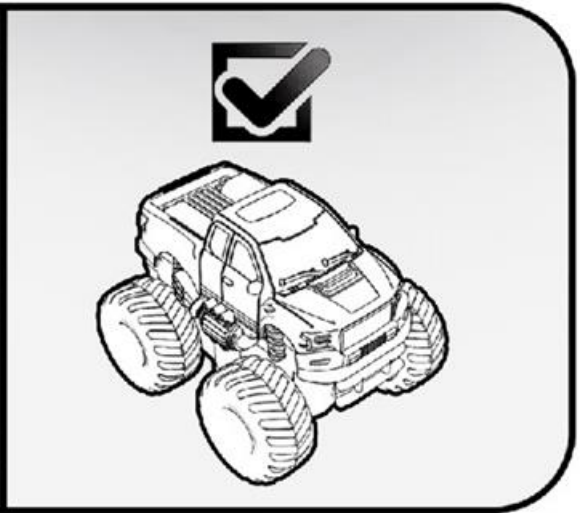
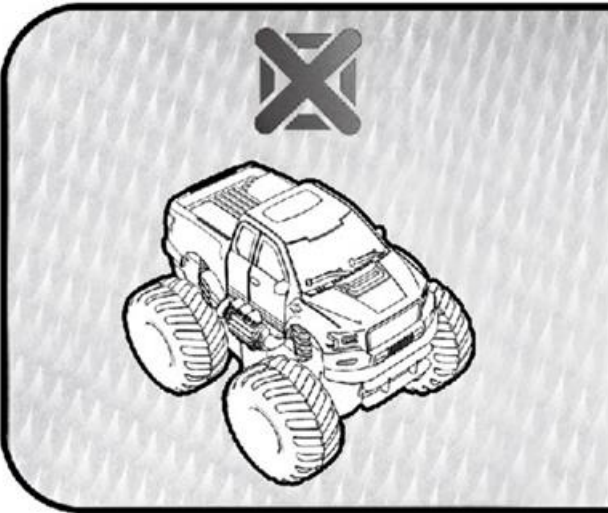
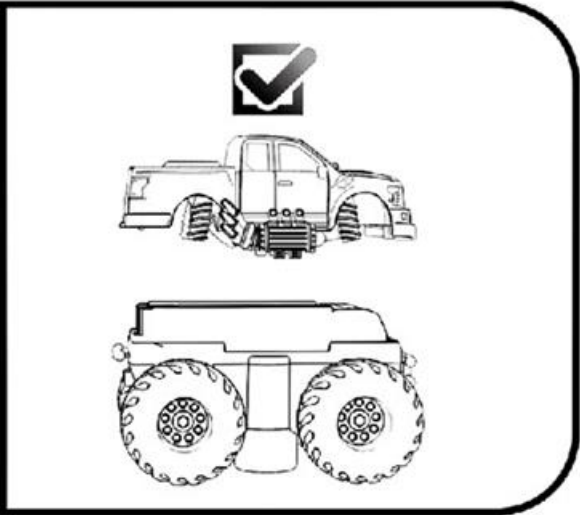
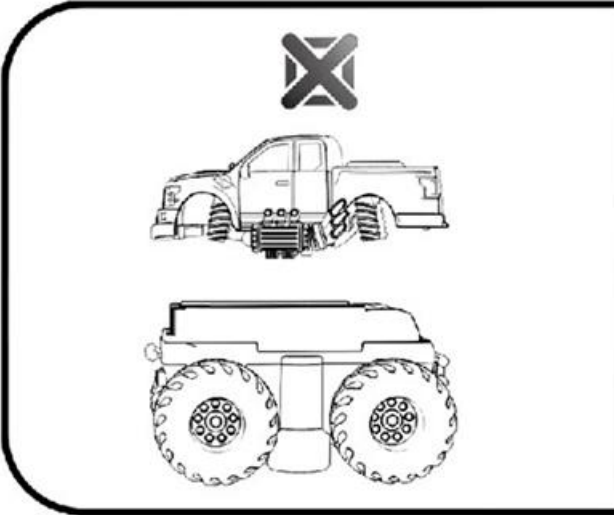
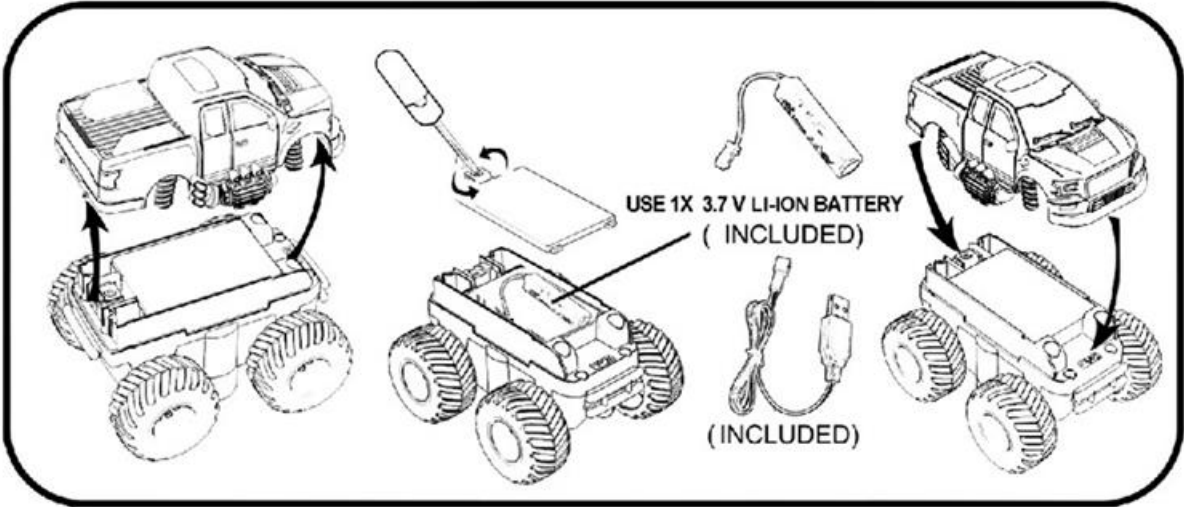

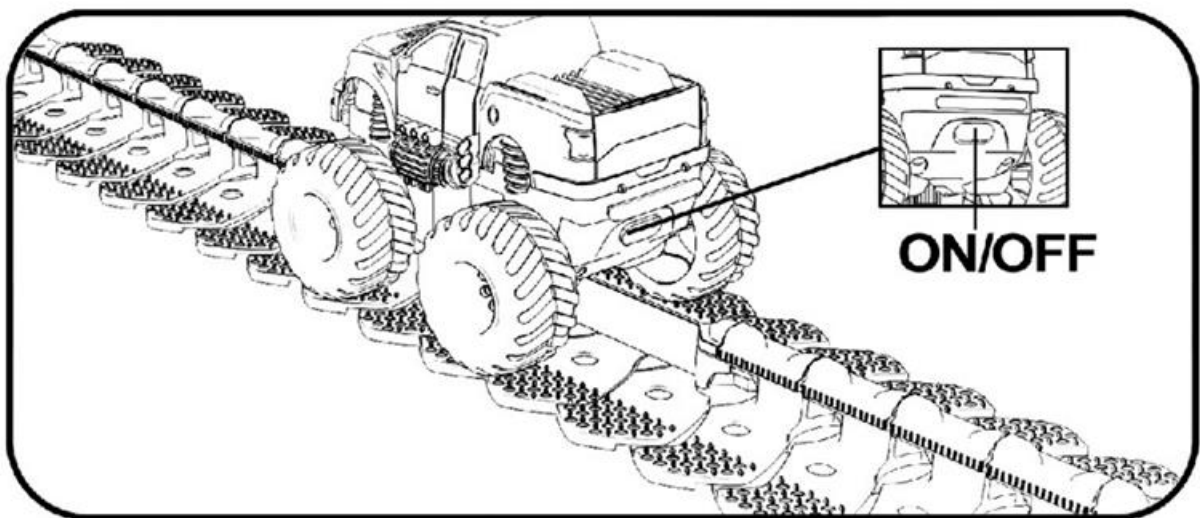
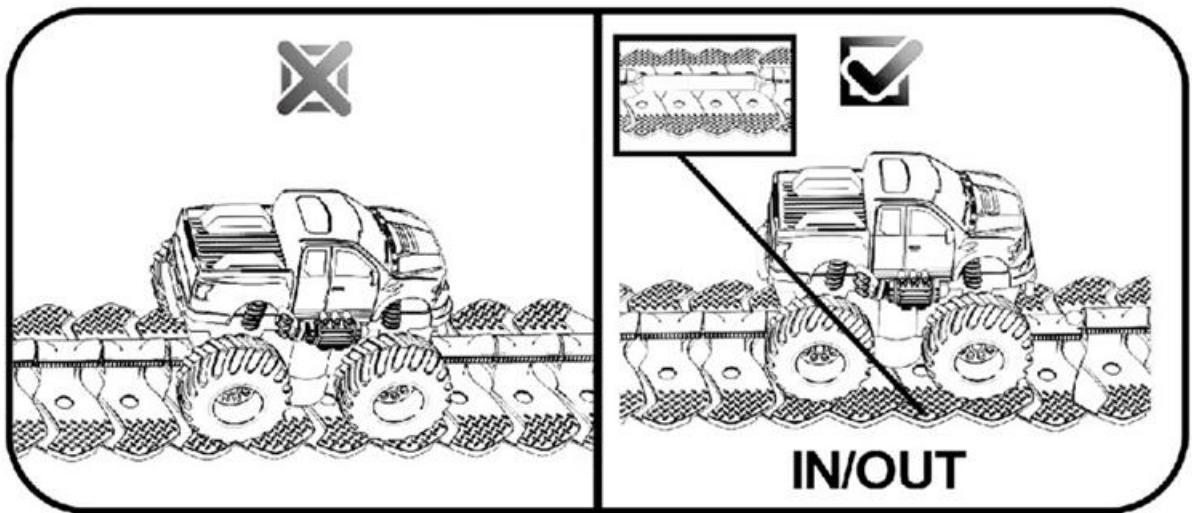

ETIKEČIŲ IŠDĖSTYMAS: AUTOMOBILIS 1









ETIKEČIŲ IŠDĖSTYMAS: AUTOMOBILIS NR. 2

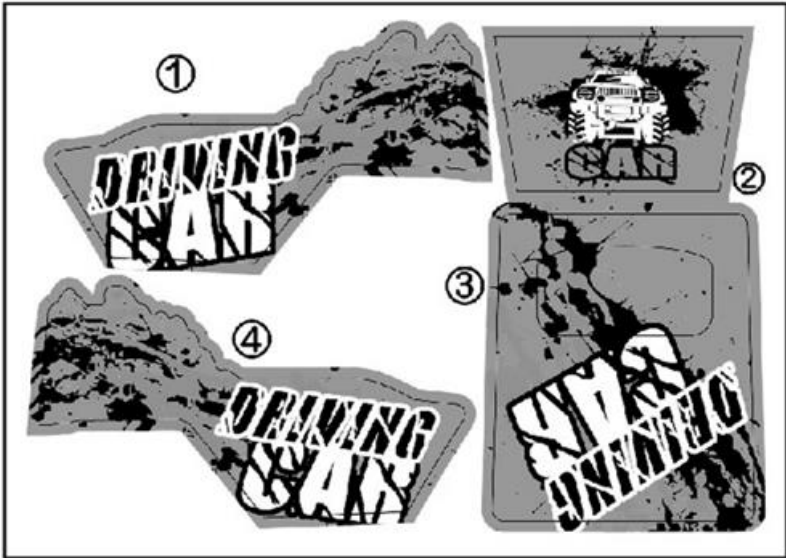



### TAKELIŲ SURINKIMAS

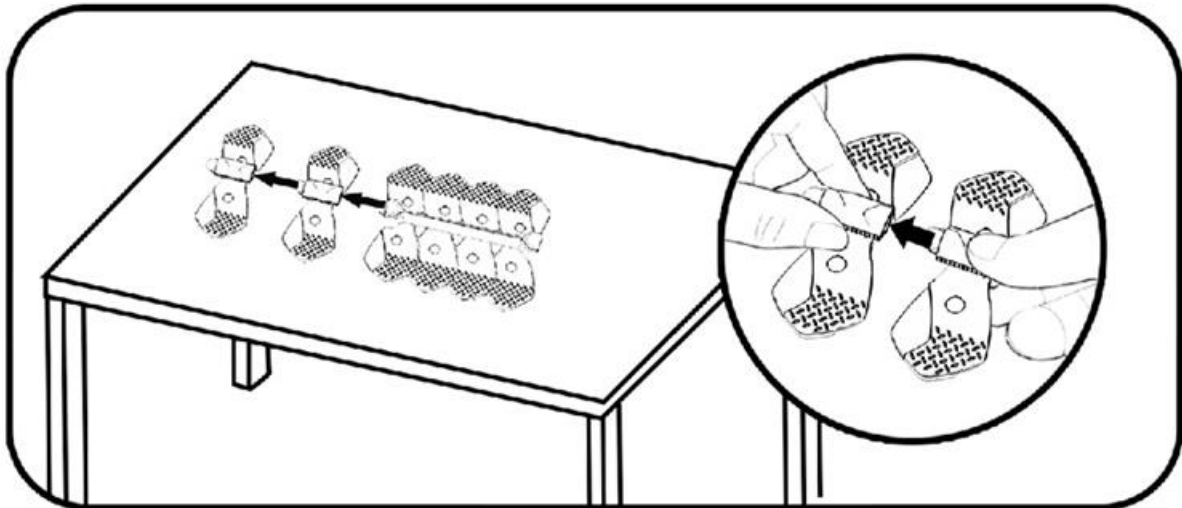

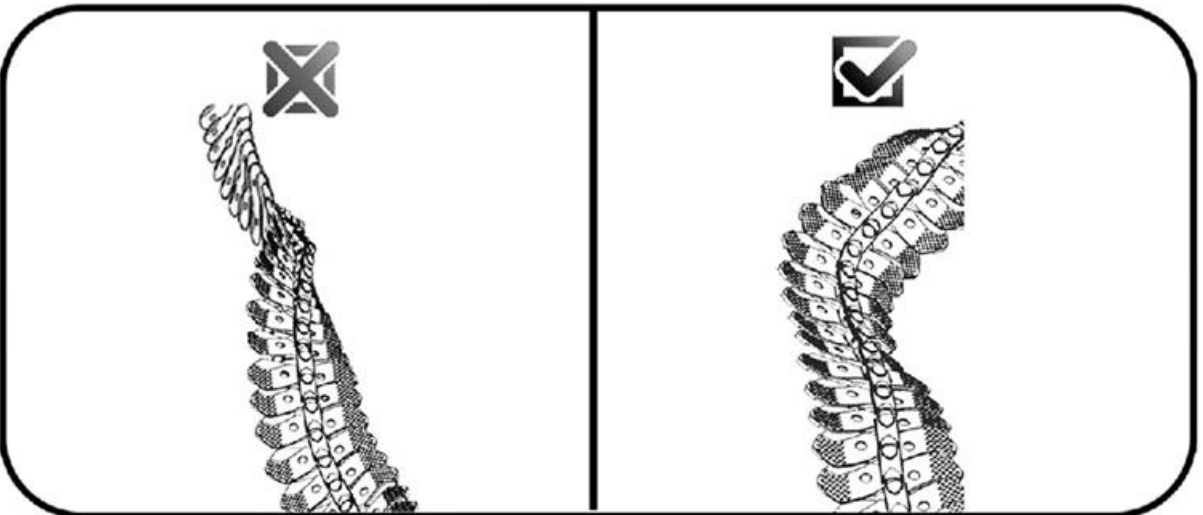
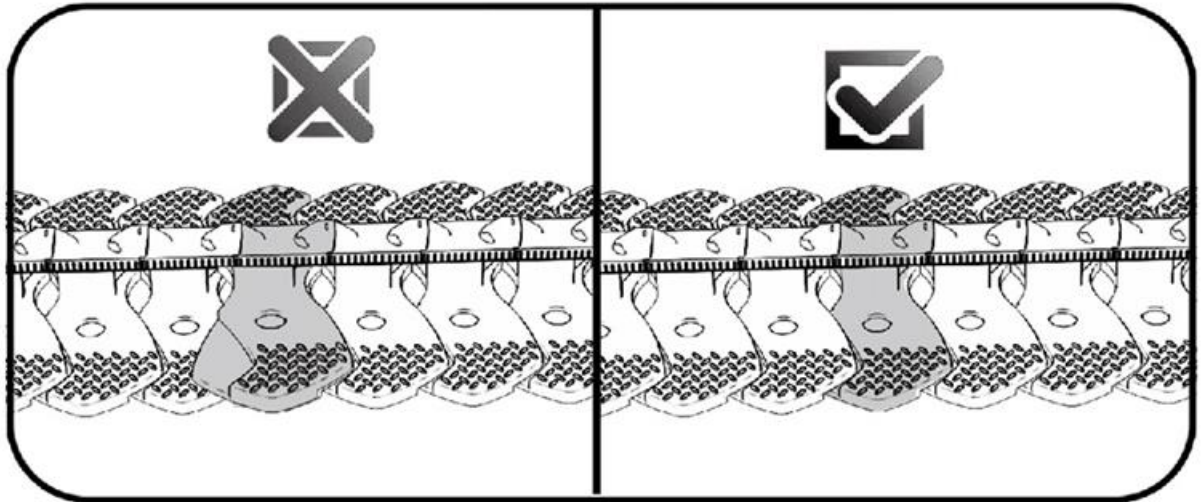
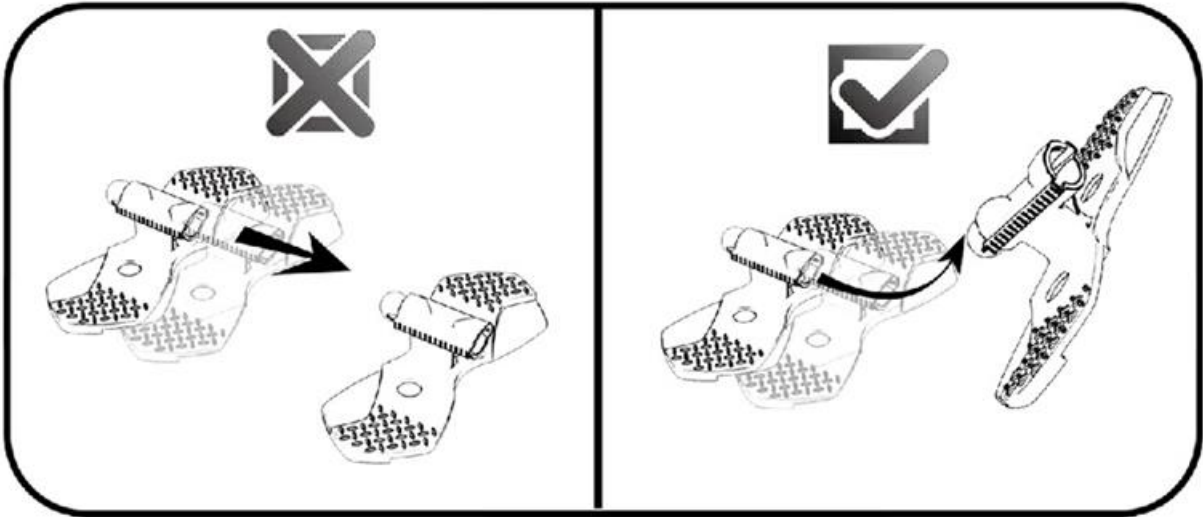

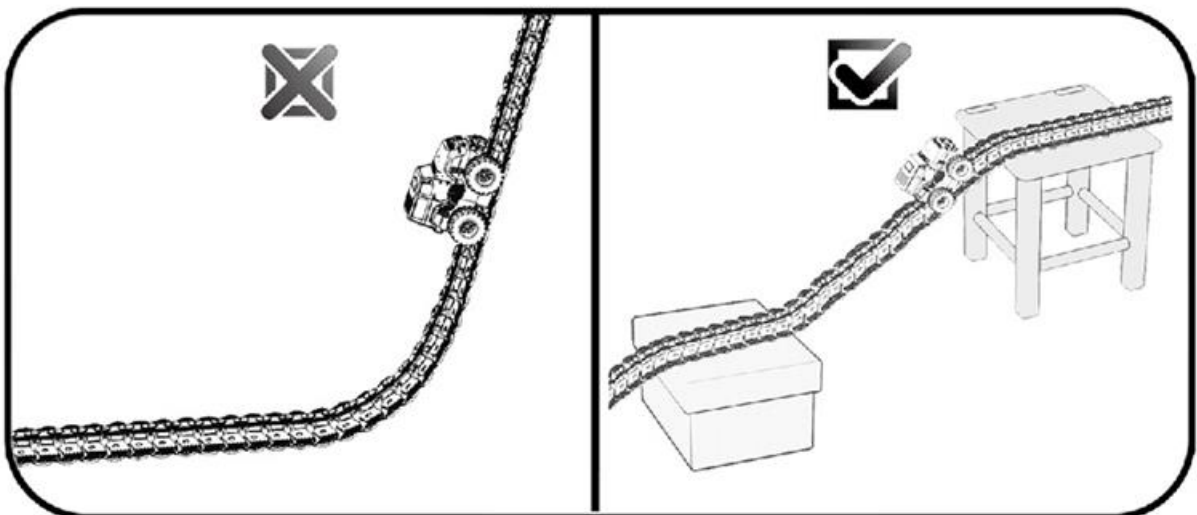
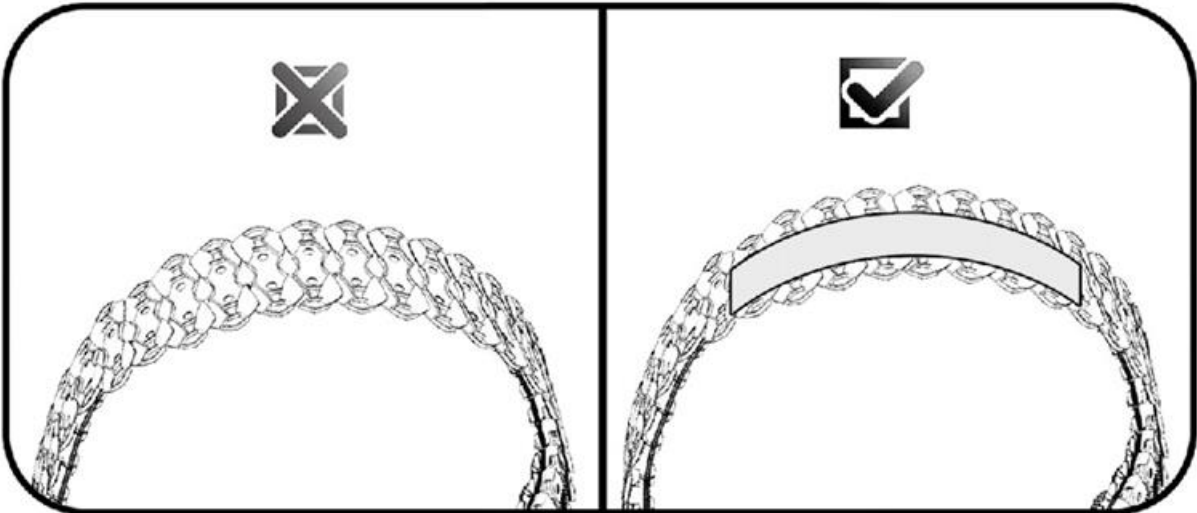
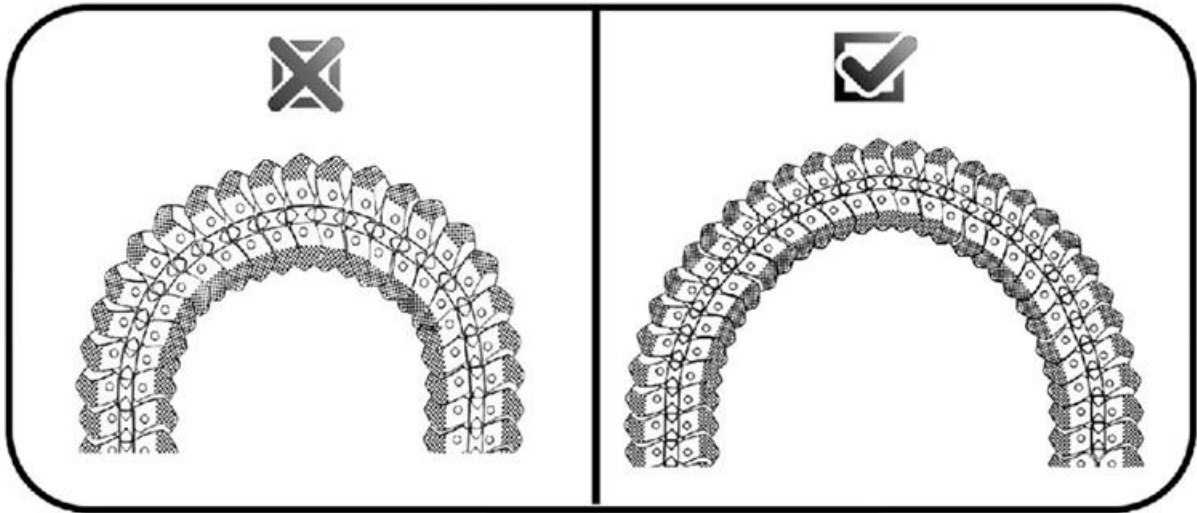



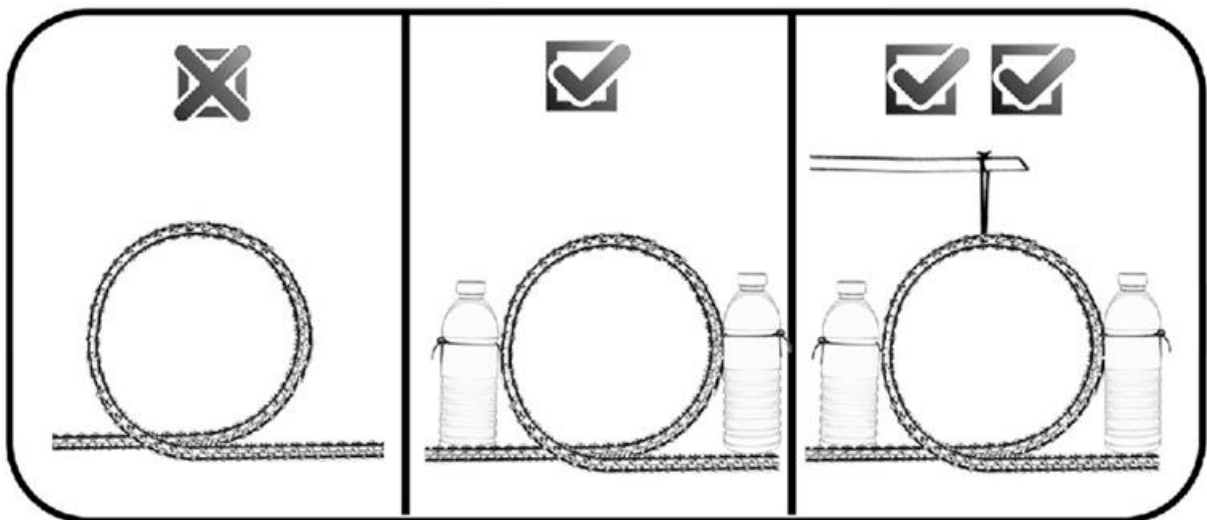
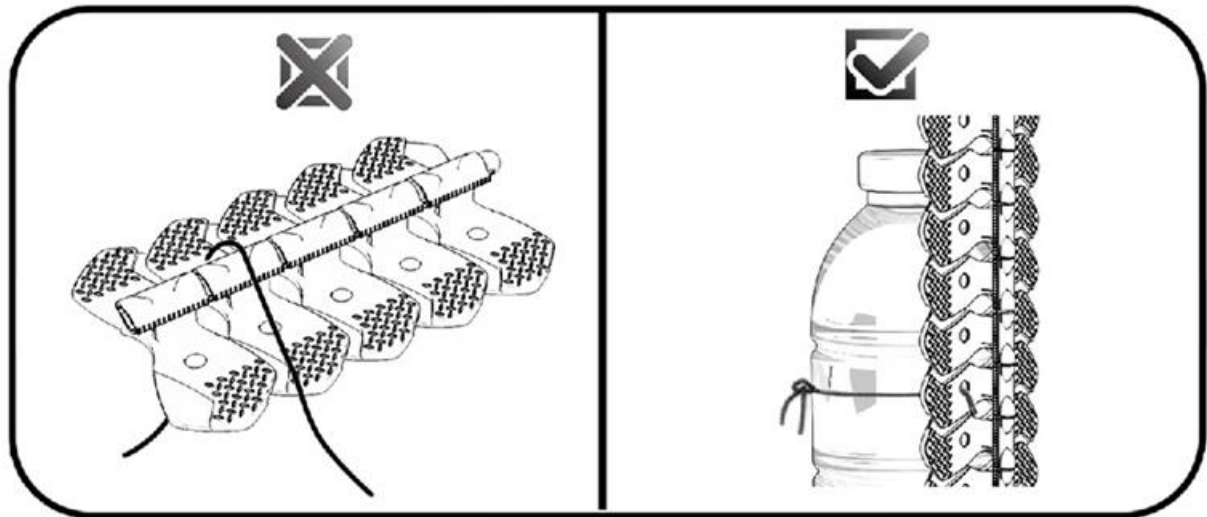
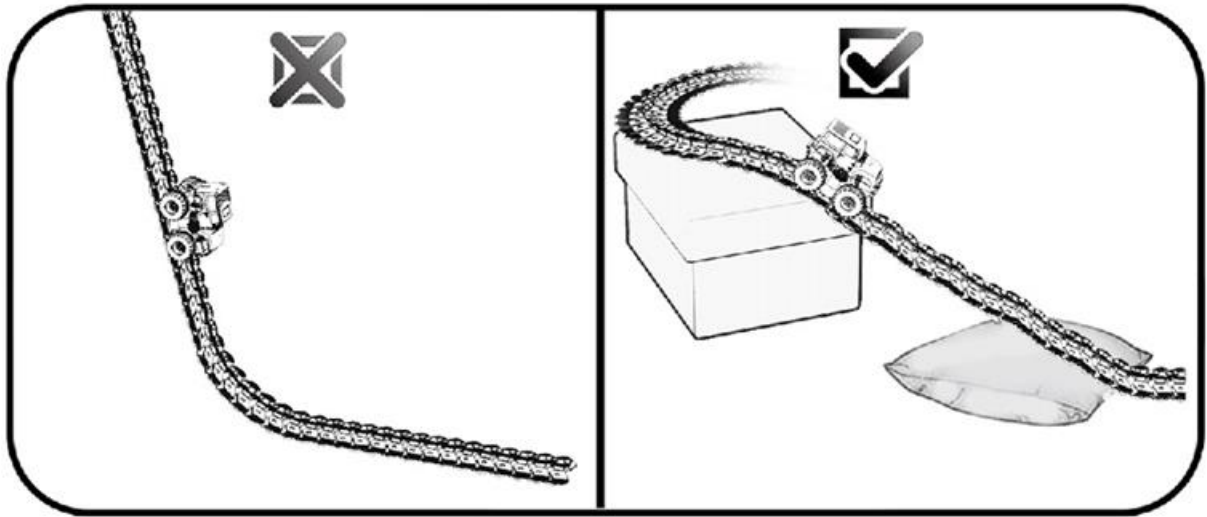

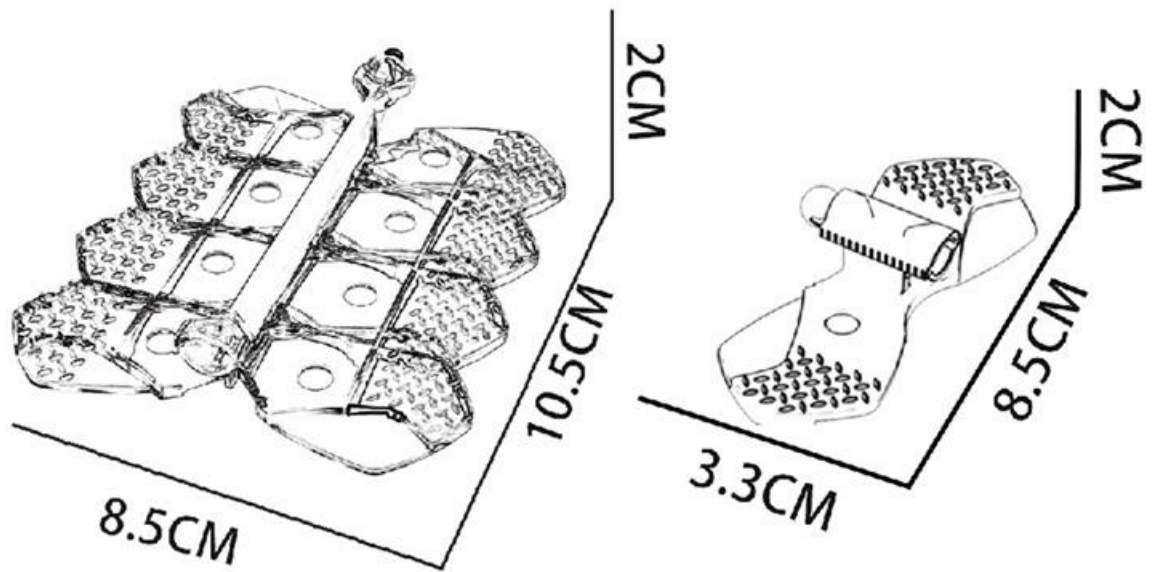

#### INSTRUKCIJOS DĖL PERDIRBIMO IR IŠMETIMO:



Ši žymė reiškia, kad produktas negali būti išmestas kaip įprastos namų ūkio atliekos visoje ES. Norint išvengti galimų žalos aplinkai ar žmonių sveikatai dėl nekontroliuojamo atliekų šalinimo. Perdirbkite atsakingai skatinant tvarų medžiagų išteklių naudojimą. Norėdami grąžinti naudotą įrenginį, naudokite atidavimo ir rinkimo sistemą arba susisiekite su pardavėju, iš kurio įsigijote produktą. Pardavėjas gali priimti produktą aplinkai saugiam perdirbimui.



Gamintojo deklaracija, kad produktas atitinka taikomus ES direktyvų reikalavimus.

## GR: LUMITRACK - ΕΓΧΕΙΡΙΔΙΟ ΧΡΗΣΗΣ

### ΦΟΡΤΙΣΗ ΤΗΣ ΜΠΑΤΑΡΙΑΣ



Η μπαταρία Li-ion 3,7V και ο φορτιστής περιλαμβάνονται στη συσκευασία του προϊόντος.

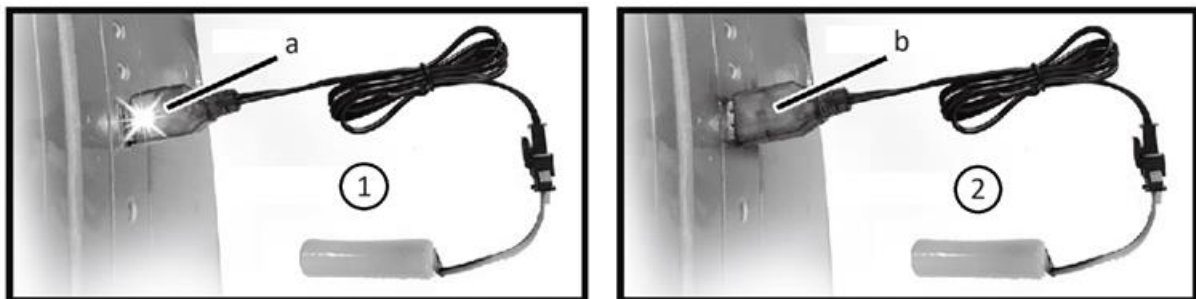

1. Φόρτιση της μπαταρίας
  - α) Φωτεινά φώτα
2. Πλήρως φορτισμένη μπαταρία
  - β) Δεν υπάρχουν φώτα

Όταν η μπαταρία είναι πλήρως φορτισμένη, το προϊόν λάμπει για 70-90 λεπτά.

ΟΔΗΓΙΕΣ ΣΥΝΑΡΜΟΛΟΓΗΣΗΣ ΑΥΤΟΚΙΝΗΤΟΥ

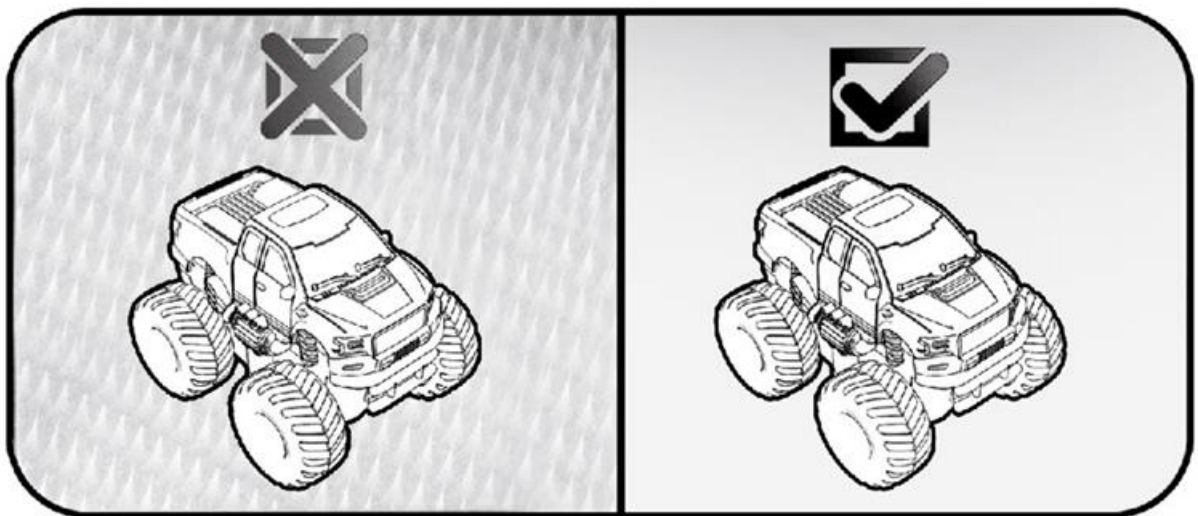
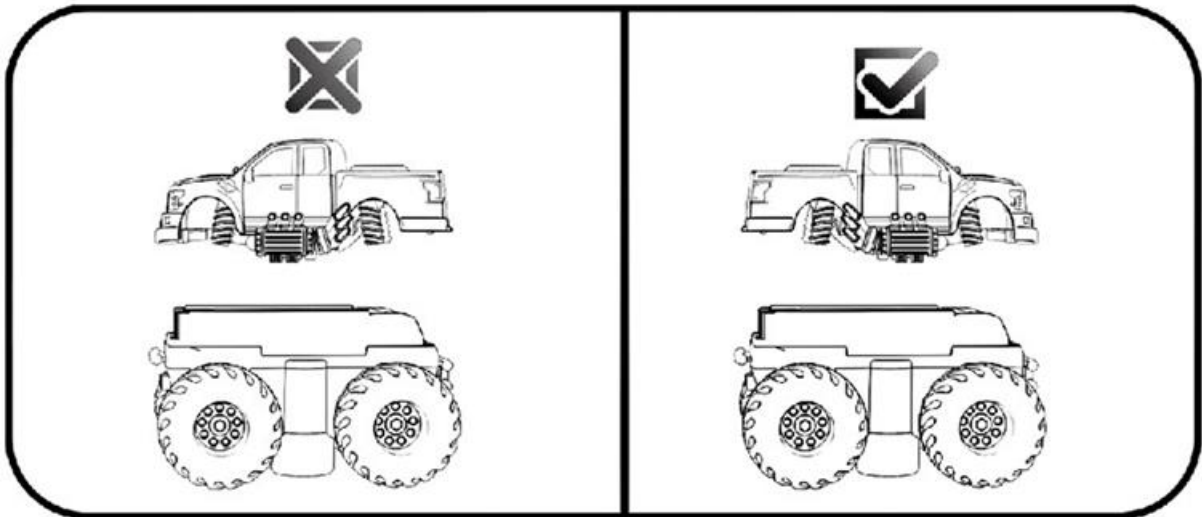
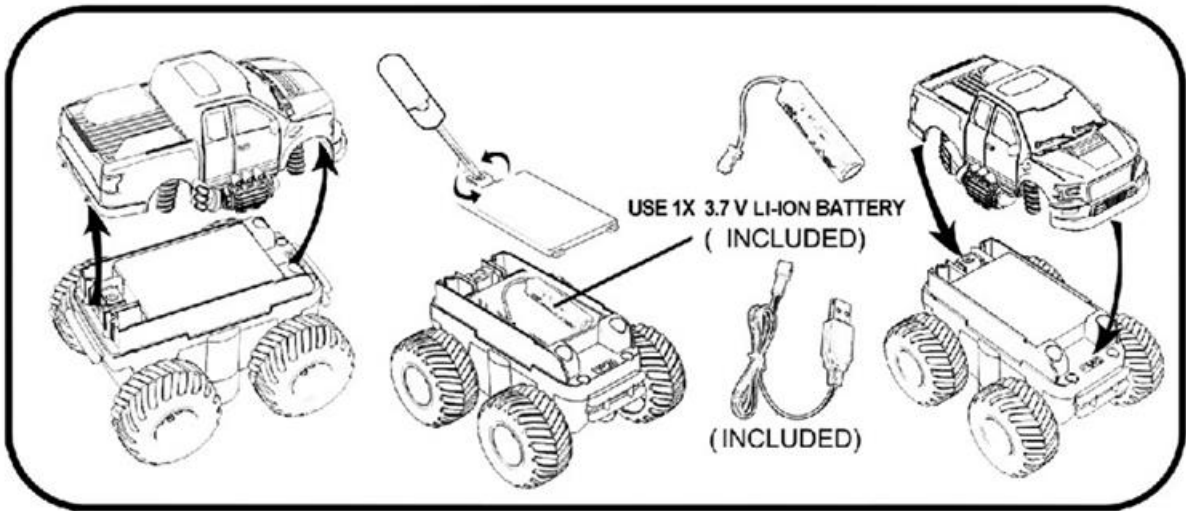



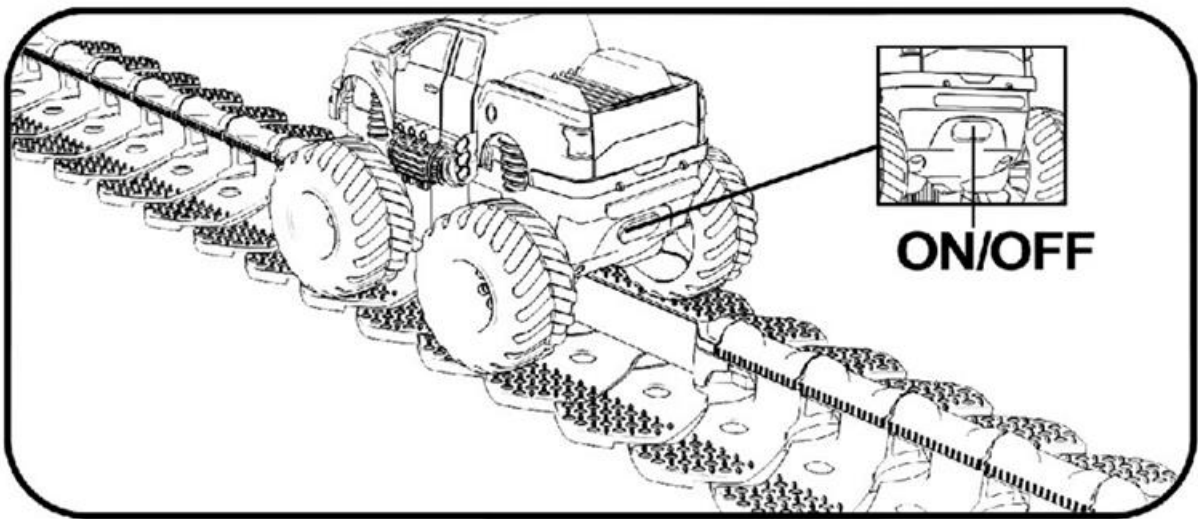
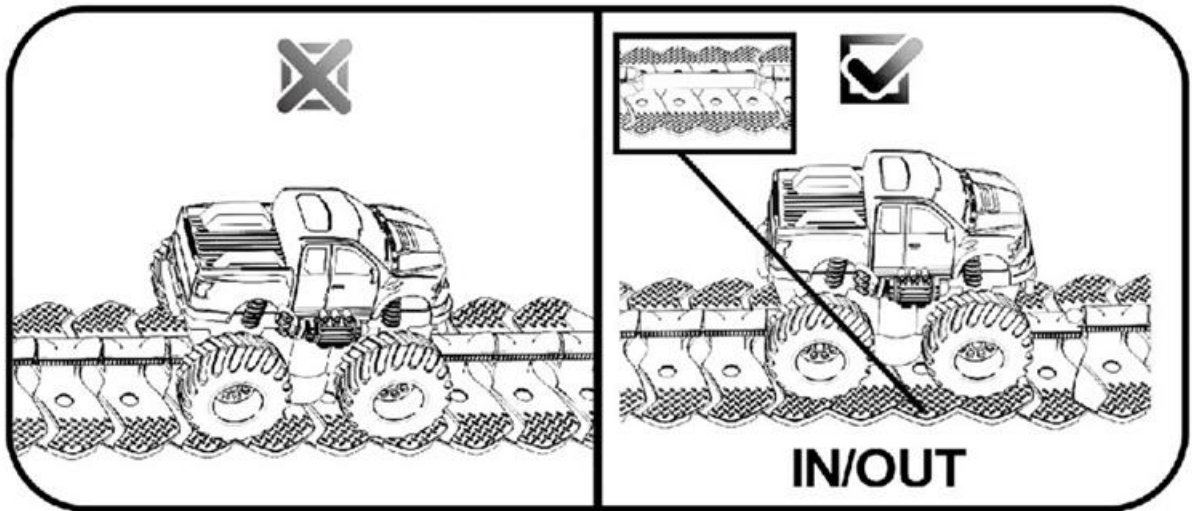

ΤΟΠΟΘΕΤΗΣΗ ΕΤΙΚΕΤΩΝ: ΑΥΤΟΚΙΝΗΤΟ 1





ΤΟΠΟΘΕΤΗΣΗ ΕΤΙΚΕΤΩΝ: CAR 2

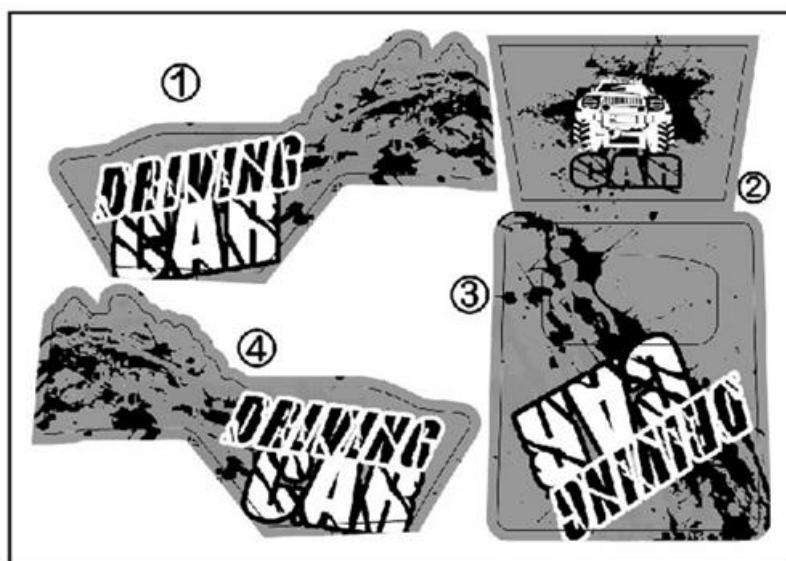





### ΣΥΝΑΡΜΟΛΟΓΗΣΗ ΚΟΜΜΑΤΙΩΝ

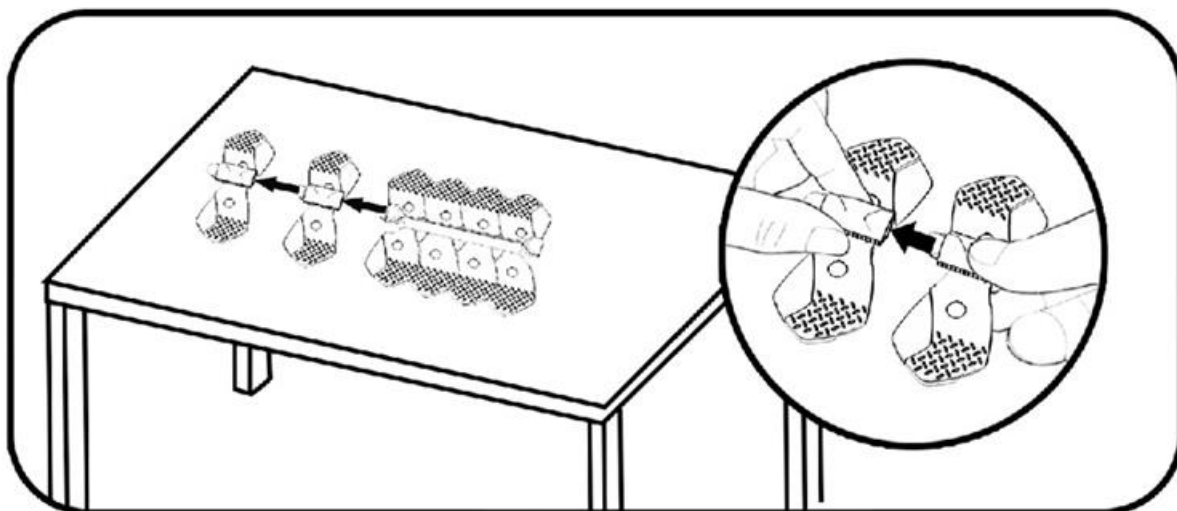



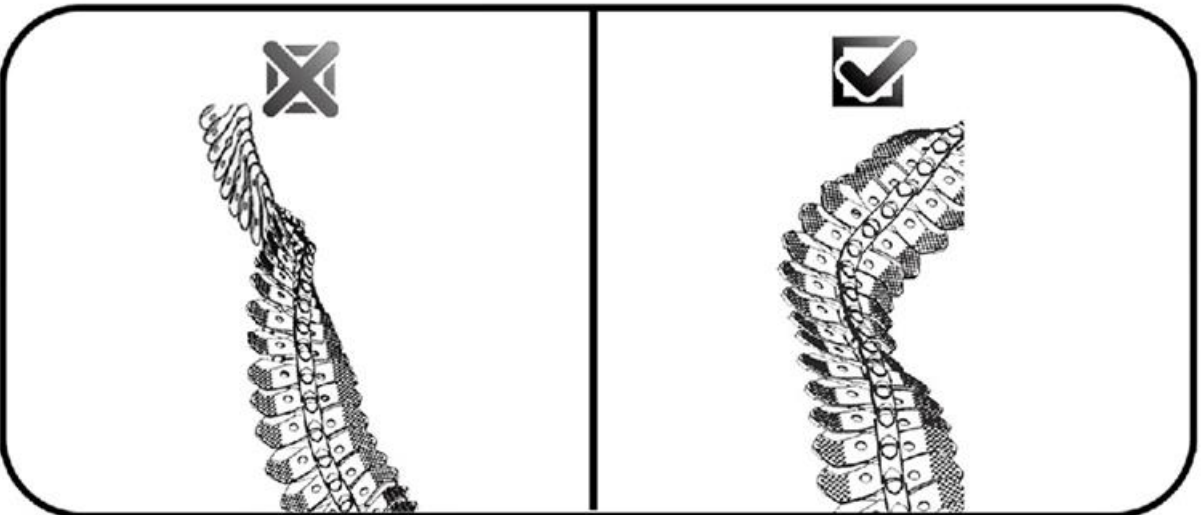
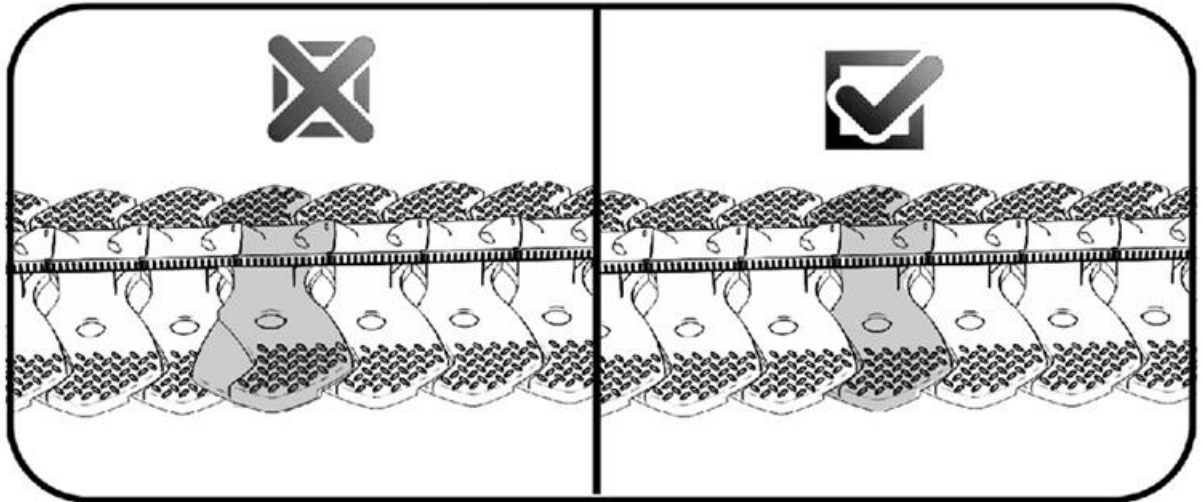
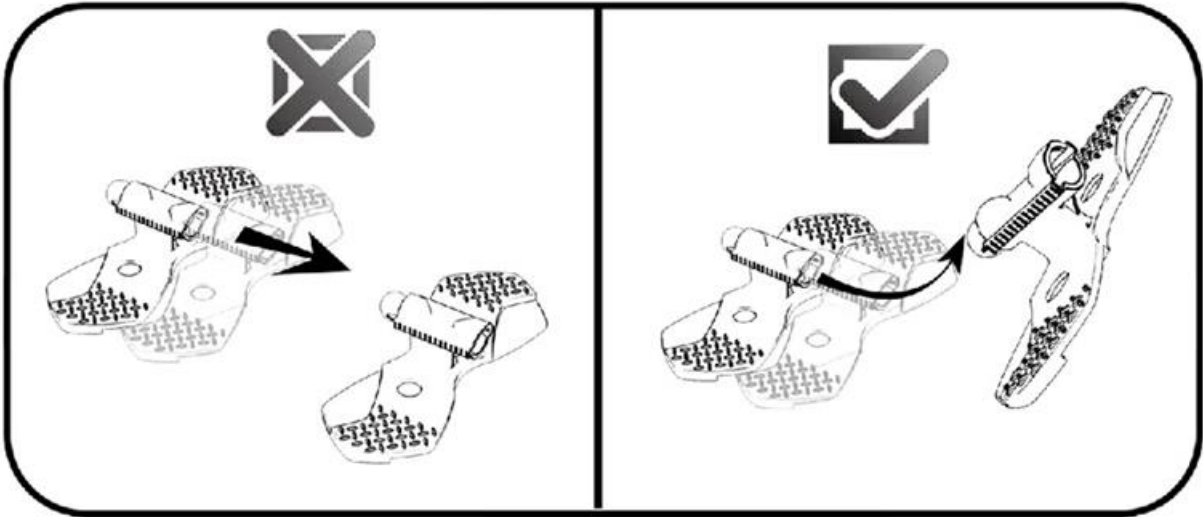

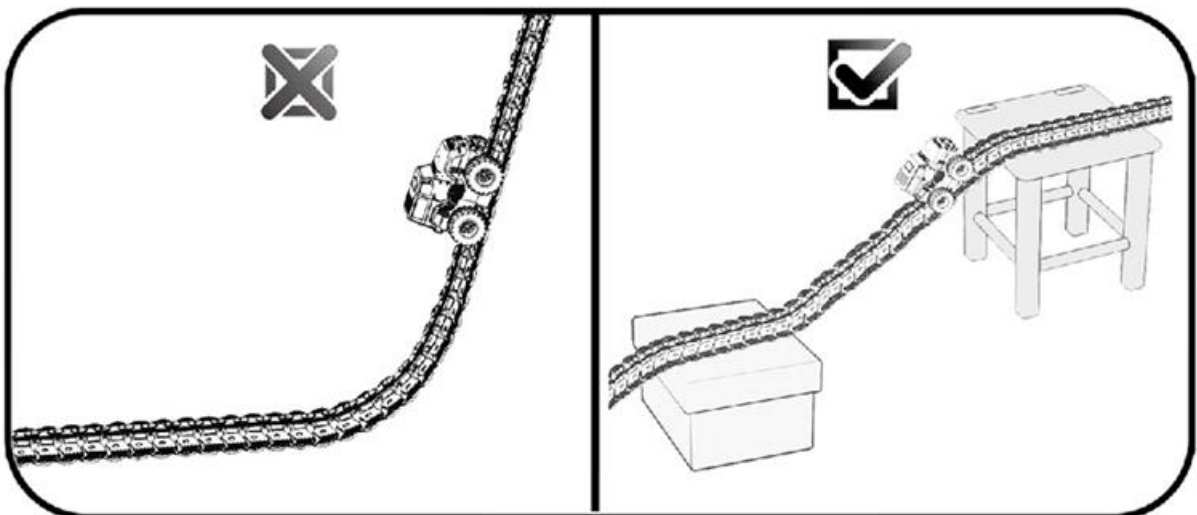
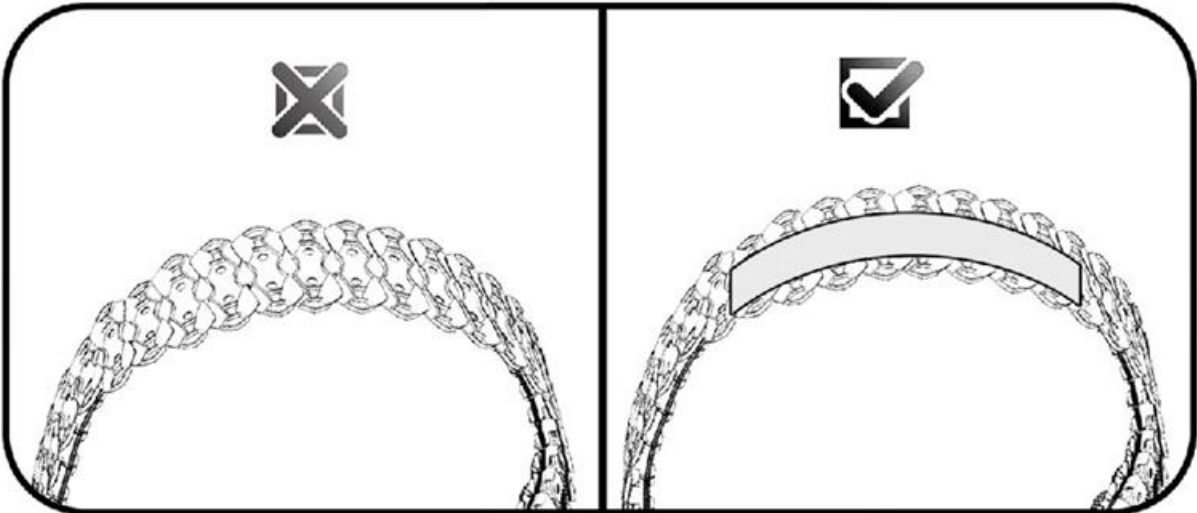
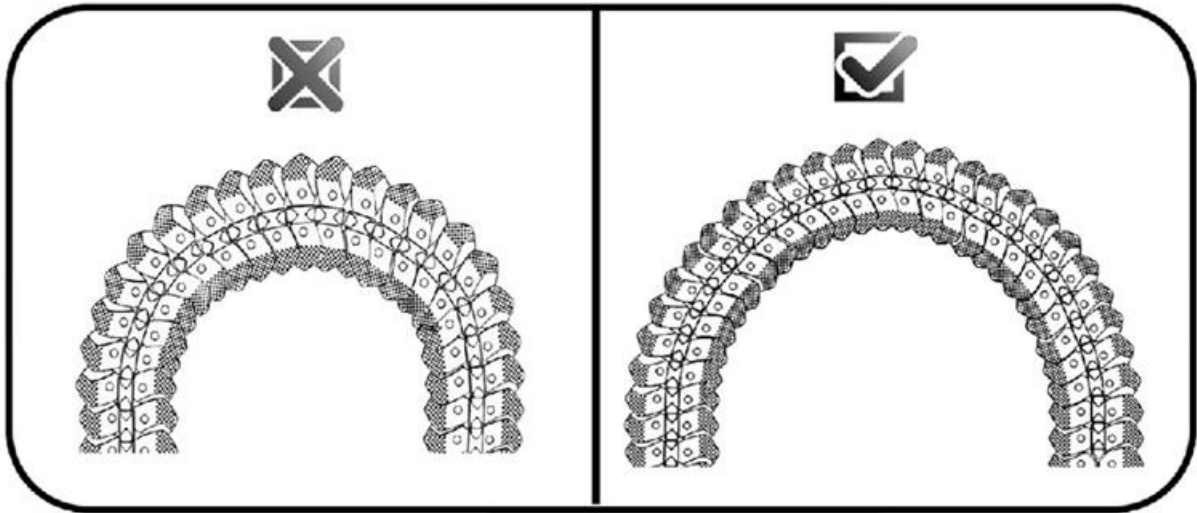

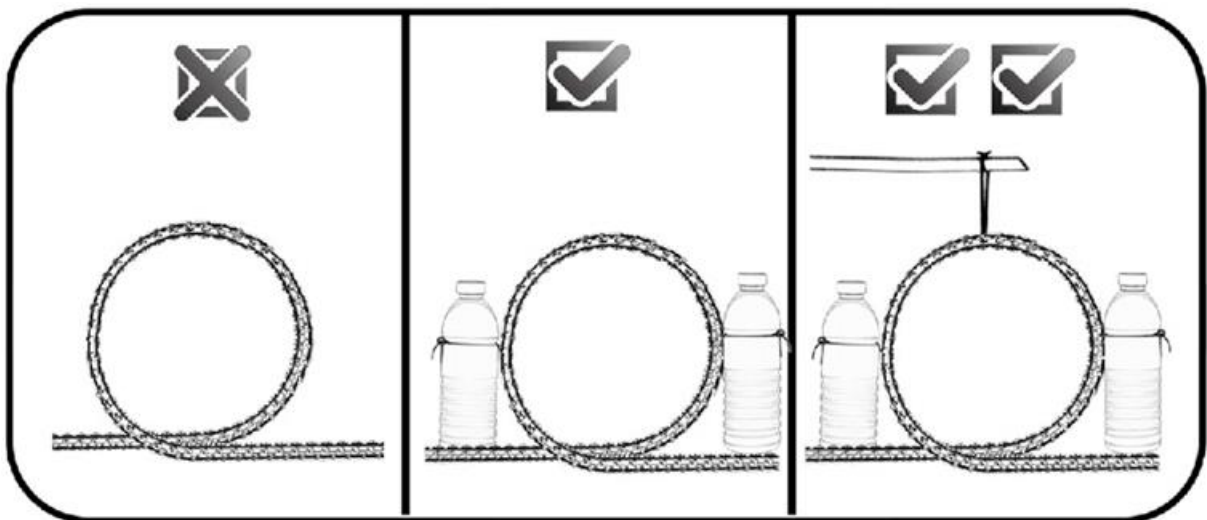
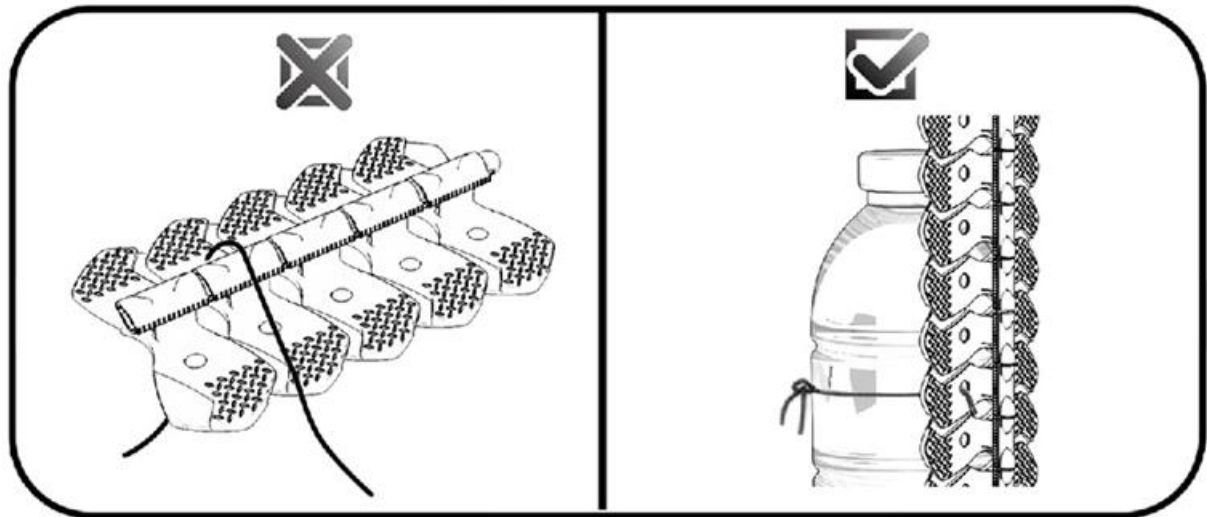
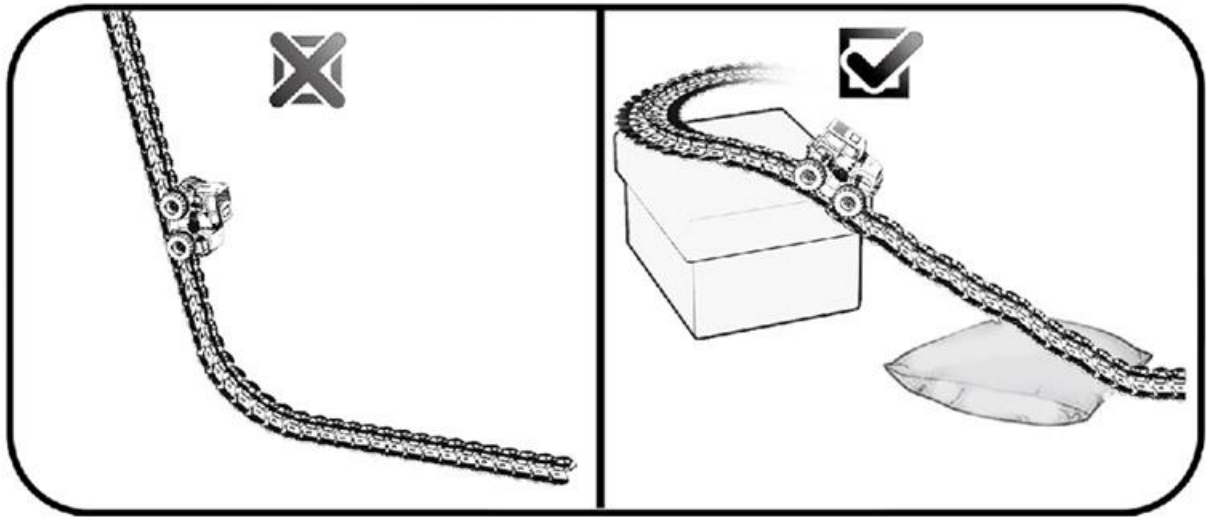

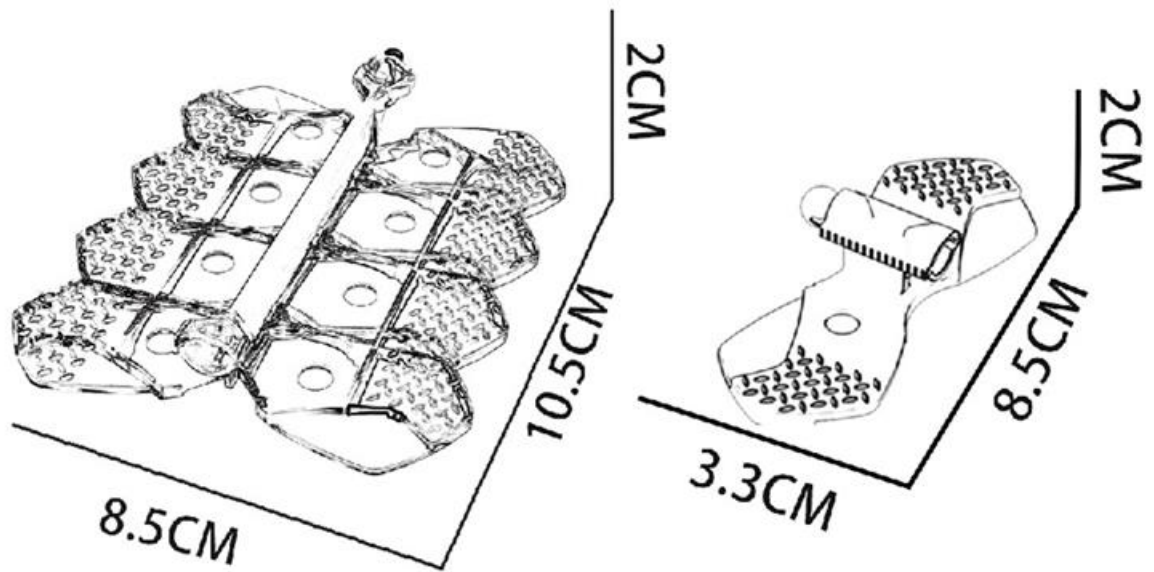

#### ΟΔΗΓΙΕΣ ΓΙΑ ΑΝΑΚΥΚΛΩΣΗ ΚΑΙ ΑΠΟΡΡΙΨΗ:



Αυτή η ετικέτα σημαίνει ότι το προϊόν δεν πρέπει να απορρίπτεται ως συνηθισμένα οικιακά απορρίμματα σε ολόκληρη την ΕΕ. Για την πρόληψη πιθανών ζημιών στο περιβάλλον ή την ανθρώπινη υγεία από μη ελεγχόμενη απόρριψη αποβλήτων. Ανακυκλώστε υπεύθυνα για την προώθηση της βιώσιμης χρήσης των υλικών πόρων. Εάν θέλετε να επιστρέψετε ένα χρησιμοποιημένο προϊόν, χρησιμοποιήστε το σύστημα παράδοσης και συλλογής ή επικοινωνήστε με τον λιανοπωλητή από τον οποίο αγοράσατε το προϊόν. Ο λιανοπωλητής μπορεί να δεχτεί το προϊόν για οικολογική ανακύκλωση.



Δήλωση του κατασκευαστή ότι το προϊόν συμμορφώνεται με τις απαιτήσεις των ισχύουσων οδηγιών της ΕΕ.